

TA-AV421

SERVICE MANUAL

US Model
Canadian Model

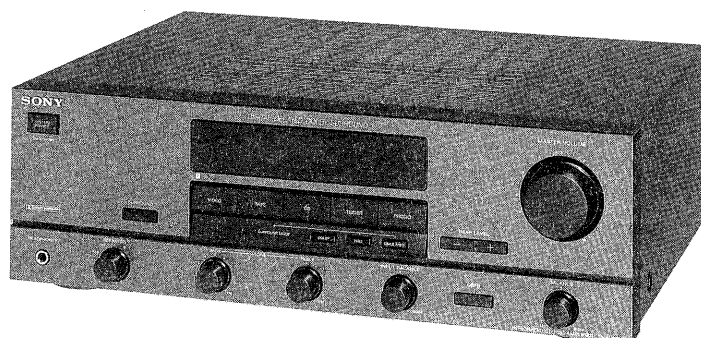

SPECIFICATIONS

AUDIO POWER SPECIFICATIONS POWER OUTPUT AND TOTAL HARMONIC DISTORTION:

With 8-ohm loads, both channels driven, from 40 - 20,000 Hz; rated 110 watts per channel minimum RMS power, with less than 0.9% total harmonic distortion from 250 milliwatts to rated output.

Frequency response

PHONO: RIAA curve
CD, VIDEO: 10 Hz - 50 kHz ± 3 dB

Input

	Sensitivity	Impedance
PHONO	2.5 mV	50 kilohms
CD, VIDEO	250 mV	50 kilohms

Output

SPEAKER: Accepts speakers of 8 to 16 ohms
HEADPHONES: Accepts headphones with low and high impedance

Rear: 10 W + 10 W
(at front off, 8 ohms)

BASS: ± 10 dB
TREBLE: ± 8 dB

Dimensions

Approx. 430 x 145 x 360 mm
(w/h/d)

Weight

(17 x 5 $\frac{3}{4}$ x 14 $\frac{1}{4}$ inches)
Approx. 9.5 kg (20 lb 15 oz) net

Power requirements
Power consumption

120 V AC, 60 Hz
220W (US model)
430VA (Canadian model)

Accessories supplied

AM loop antenna (1)
FM wire antenna (1)
Remote Commander RM-U421 (1)
Sony batteries SUM-3(NS) (2)
Audio signal connecting cord
(phono plug x 2 \leftrightarrow
phono plug x 2) (1)
SYSTEM CONTROL 1 cord (1)
SYSTEM CONTROL 2 cord (1)
SYSTEM CONTROL 3 cord (1)
(For USA model, the SYSTEM
CONTROL 1 and 3 is equipped on
the TC-W421.)
Model only for Canada:
Headphone MDR-006 (1)
Plug adaptor (1)

Design and specifications are subject to change without notice.

INTEGRATED STEREO AMPLIFIER
SONY[®]

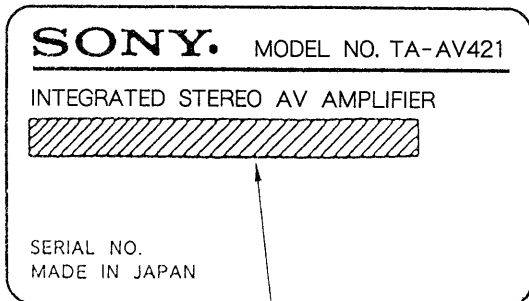

TABLE OF CONTENTS

<u>Section</u>	<u>Title</u>	<u>Page</u>
1. GENERAL		3
2. DIAGRAMS		
2-1. IC Block Diagrams.....		6
2-2. IC Description		7
2-3. Circuit Boards Location		11
2-4. Printed Wiring Boards.....		12
2-5. Schematic Diagram —Main Section—		17
2-6. Schematic Diagram —Power Section—		21
2-7. Semiconductor Lead Layouts		23
3. EXPLODED VIEWS		
3-1. Overall Section 1		24
3-2. Overall Section 2		25
4. ELECTRICAL PARTS LIST		26
HARDWARE LIST		34

MODEL IDENTIFICATION

— Specification Label —



US model: AC 120V 60Hz 220W

Canadian model: AC 120V 60Hz 430VA

SAFETY-RELATED COMPONENT WARNING!!

COMPONENTS IDENTIFIED BY MARK OR DOTTED LINE WITH MARK ON THE SCHEMATIC DIAGRAMS AND IN THE PARTS LIST ARE CRITICAL TO SAFE OPERATION. REPLACE THESE COMPONENTS WITH SONY PARTS WHOSE PART NUMBERS APPEAR AS SHOWN IN THIS MANUAL OR IN SUPPLEMENTS PUBLISHED BY SONY.

ATTENTION AU COMPOSANT AYANT RAPPORT À LA SÉCURITÉ!

LES COMPOSANTS IDENTIFIÉS PAR UNE MARQUE SUR LES DIAGRAMMES SCHÉMATIQUES ET LA LISTE DES PIÈCES SONT CRITIQUES POUR LA SÉCURITÉ DE FONCTIONNEMENT. NE REMPLACER CES COMPOSANTS QUE PAR DES PIÈCES SONY DONT LES NUMÉROS SONT DONNÉS DANS CE MANUEL OU DANS LES SUPPLÉMENTS PUBLIÉS PAR SONY.

SAFETY CHECK-OUT

After correcting the original service problem, perform the following safety check before releasing the set to the customer:

Check the antenna terminals, metal trim, “metallized” knobs, screws, and all other exposed metal parts for AC leakage. Check leakage as described below.

LEAKAGE TEST

The AC leakage from any exposed metal part to earth ground and from all exposed metal parts to any exposed metal part having a return to chassis, must not exceed 0.5 mA (500 microampers). Leakage current can be measured by any one of three methods.

1. A commercial leakage tester, such as the Simpson 229 or RCA WT-540A. Follow the manufacturers’ instructions to use these instruments.
2. A battery-operated AC milliammeter. The Data Precision 245 digital multimeter is suitable for this job.
3. Measuring the voltage drop across a resistor by means of a VOM or battery-operated AC voltmeter. The “limit” indication is 0.75 V, so analog meters must have an accurate low-voltage scale. The Simpson 250 and Sanwa SH-63Trd are examples of a passive VOM that is suitable. Nearly all battery operated digital multimeters that have a 2V AC range are suitable. (See Fig. A)

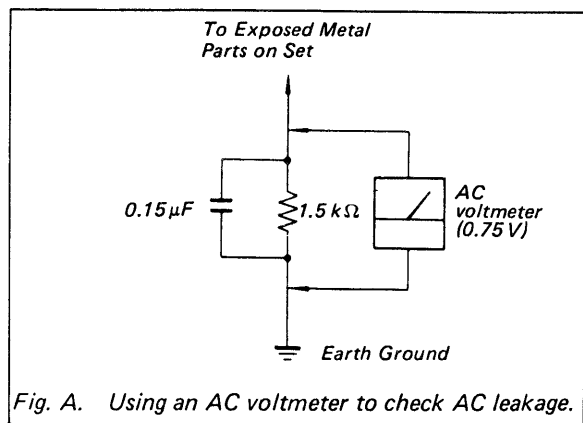

Fig. A. Using an AC voltmeter to check AC leakage.

SECTION 1 GENERAL

This section is extracted from instruction manual.

Remote Commander

The remote commander supplied with this unit can control the unit from a distance.
The remote commander is divided into 6 sections according to the functions as shown below.

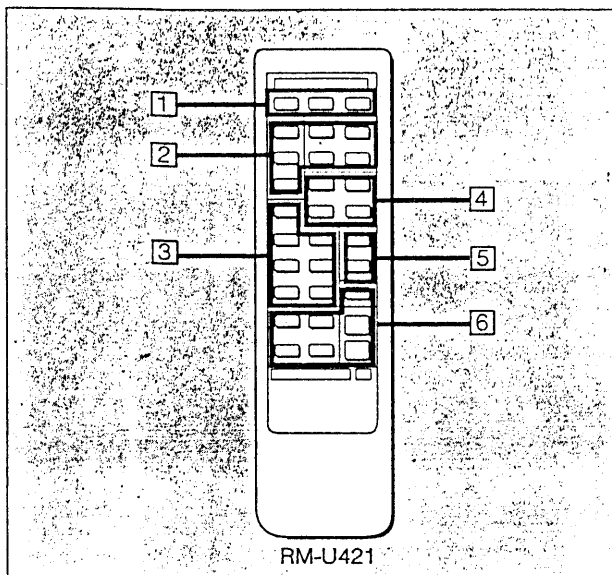

1 Power control block

VCR 3/TV/AUDIO POWER buttons: Control the power of each unit.

2 TV/VTR control block

VCR 3 operation buttons:

▶: Play

■: Stop

ANT (antenna) TV/VTR button: Selects the output signal from the antenna terminal on the VCR, either a TV signal or VCR programs.

TV VOL (volume) +/- buttons: Control the volume of TV.

TV CH (channel) +/- buttons: Select the channel of the TV.

3 CD control block

SHUFFLE button: Set to the shuffle play mode.

▶: Play

In the TUNER mode:

Press CD ▶ once, the unit enters the CD mode.

Press CD ▶ twice, the CD player starts playback.

In the mode other than the TUNER mode:

Press CD ▶ once, the unit enters the CD mode and starts playback.

■: Stop

◀◀/▶▶ (AMS: Automatic Music Search): Locates a desired selection.

D (disc) SKIP button: Disc skip

CONTINUE button: Set to the continuous play mode.

4 SURROUND control block

SURROUND mode selectors (for the amplifier)

ON/OFF: Turns on/off the surround mode.

MODE: Selects the surround mode.

REAR VOL +/- buttons: Control the volume of rear speakers (surround level).

5 Tuner control block

TUNER PRESET +/- buttons: Select a preset station of the tuner.

6 Amplifier control block

FUNCTION selectors: Select an input source of the amplifier.(for the amplifier)

DBFB button: Turns on/off the DBFB (Dynamic Bass Feed Back). (for the amplifier)

MASTER VOL +/- buttons: Control the amplifier volume.

Battery life

About half a year of normal operation can be expected when using the Sony SUM-3 (NS) batteries. When the batteries are exhausted, the remote commander can no longer operate the unit. If this happens, replace both batteries with new ones.

To avoid battery leakage

When the commander is not be used for a long time, remove the batteries to avoid damage caused by battery leakage and corrosion.

Inserting the batteries into the remote commander

1 Open the cover.

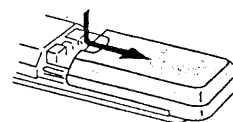

2 Insert two size-AA (R6) batteries with correct polarity

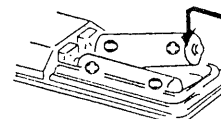

Hooking Up the System

- Connect the AC power cord last. Make sure power is off.
- Cord plugs and jacks are color coded. Red plugs and jacks are for right channel (R) and white ones for the left channel (L).
- The cable connectors should be fully inserted into the jacks. A loose connection may cause hum and noise.
- Keep speaker cords, connecting cords and power cords away from the AM loop antenna and the tuner's antenna lead-in to avoid possible noise pickup.

The numbers correspond to the following details:

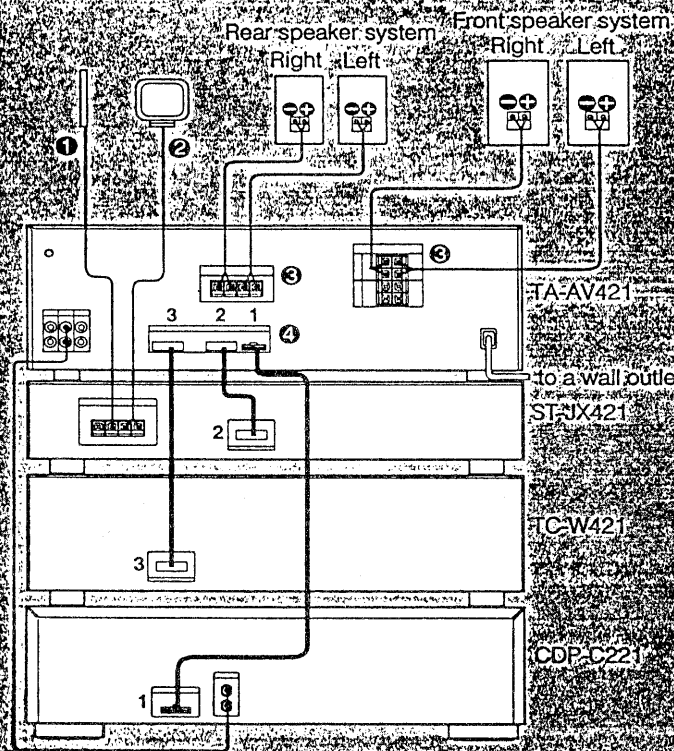

Note:
The CD player is automatically turned off in the TUNER mode.

● FM wire antenna (supplied)

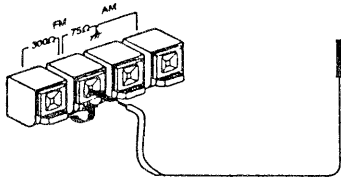

For better FM reception

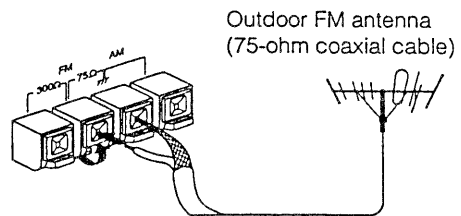

Hooking Up the System

CAUTION

Do not put anything like another unit to obstruct the ventilation holes on the top of the unit.
The level surface installation is required for essential air ventilation to prevent internal heat built up in the unit.

2 AM loop antenna (supplied)

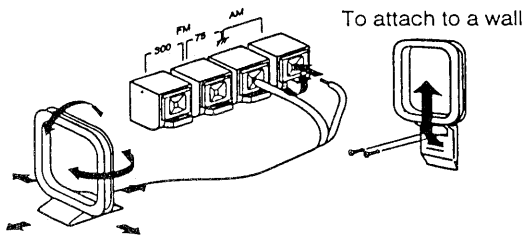

For better AM reception

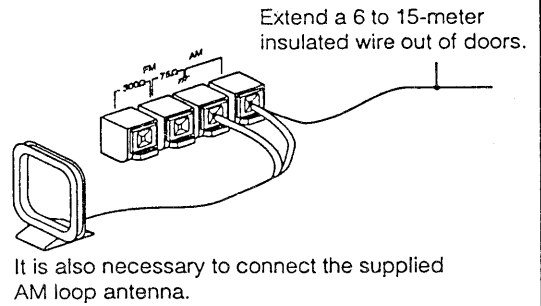

3 Speaker cords

Front speakers

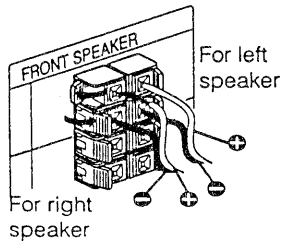

Rear speakers

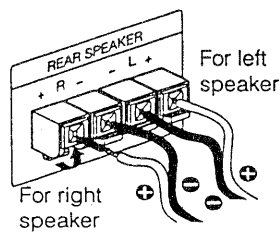

4 SYSTEM CONTROL cord (Supplied)

For the SYSTEM CONTROL 1

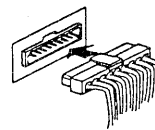

Push in until it clicks.

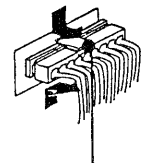

To disconnect, pull out while pressing here.

Adding other audio equipments to your system

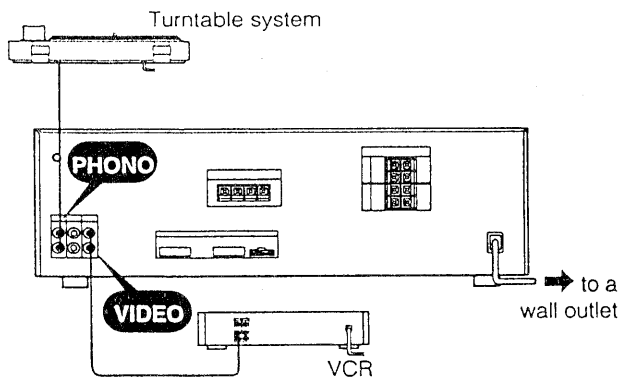

For the SYSTEM CONTROL 2 and 3

Connect the blue and black connectors to the same color connector jacks respectively for controlling each unit.

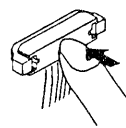

Push in until it clicks.

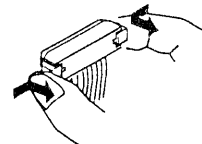

To disconnect, pull out while pressing the both sides of levers.

Note for the USA model

The SYSTEM CONTROL 2 and 3 is equipped on the TC-W421.

SECTION 2 DIAGRAMS

2-1. IC BLOCK DIAGRAMS

• IC403 LB1639

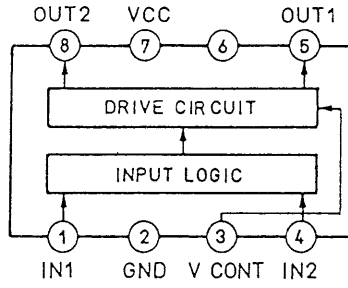

• IC401 LC7535

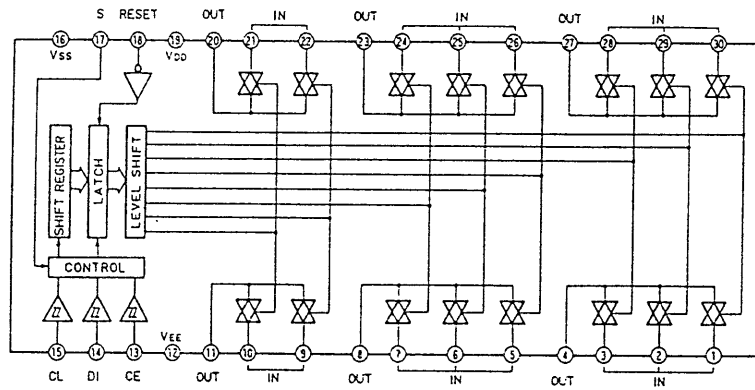

• IC502 LC7822

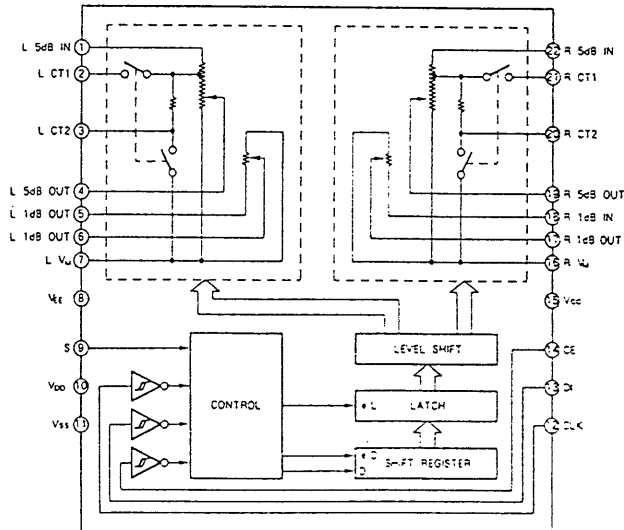

• IC701 μ PC1237HA

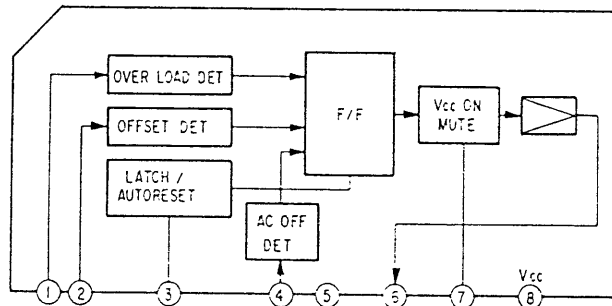

2-2. IC DESCRIPTION

● IC101 (μ PD75206GF-722-3BE)

Pin	Port	I/O	ACT	RESET	Outside	
1	RESET	I				
2	t0	O	H	High	L	DIGIT2
3	t1	O	H	High	L	DIGIT1
4	t2	O	H	High	L	DIGIT3
5	t3	O	H	High	L	DIGIT4
6	t4	O	H	High	L	DIGIT5
7	t5	O	H	High	L	DIGIT6
8	t6	O	H	High	L	DIGIT7
9	t7	O	H	High	L	DIGIT8
10	t8	O	H	High	L	DIGIT9
11	t9	O	H	High	L	NC
12	t10	O	L	High	L	REAR MUTE
13	t11	O	L	High	L	FRONT MUTE
14	t12	O	L	High	L	V-2 (NO USE)
15	t13	O	L	High	L	V-1 REC (NO USE)
16	t14	O	L	High	L	SURROUND A
17	t15	O	L	High	L	SURROUND B
18	Vload		-	High		- 30V
19	vpre		-	High		- 4V
20	s9	O	H	High	L	DBFB
21	s8	O	H	High	L	SEG1
22	s7	O	H	High	L	SEG2
23	s6	O	H	High	L	SEG3
24	s5	O	H	High	L	SEG4
25	s4	O	H	High	L	SEG5/KEY OUT 5
26	VDD			High		+ 5V
27	s3	O	H	High	L	SEG6/KEY OUT 4
28	s2	O	H	High	L	SEG7/KEY OUT 3
29	s1	O	H	High	L	SEG8/KEY OUT 2
30	s0	O	H	High	L	SEG9/KEY OUT 1
31	p00	I	H	In	L	STOP
32	p01	I	H	In	L	KEY IN 2

High : High-impedance status

In : Input status

Pin	Port	I/O	ACT	RESET	Outside	
33	p02	I	H	In	L	KEY IN 3
34	p03	I	H	In	L	KEY IN 4
35	p10	I	H	In	L	KEY IN 5
36	p11	I	H	In		RM-IN 1
37	p12	I	L	In		KEY IN 1
38	p13	I	L	In		POWER SW
39	p20	O	H	In	L	ST LC7535/LC7822
40	p21	O	L	In	L	ST LV1001M
41	p22	O	H	In	L	VOL +
42	p23	O	H	In	L	VOL -
43	p30	O	H	In	L	VIDEO A
44	p31	O	H	In	L	VIDEO B
45	p32	O	H	In	L	VIDEO C
46	p33	O	H	In	L	AUTO LED
47	p60	O	H	In	L	CD CONTROL
48	p61	O	H	In	L	CLOCK
49	p62	O	H	In		DATA
50	p63	O	H	In		FRONT SP RELAY
51	p40	O	H	In	L	REAR SP RELAY
52	p41	O	H	In	L	CENTER SP RELAY (NO USE)
53	p42	O	L	In	L	CENTER MUTE (NO USE)
54	p43	O	H	In	L	POWER RELAY
55	ppo	O	H	In	L	P LOGIC 1 (NO USE)
56	x1					
57	x2					
58	Vss					
59	xt1					
60	zt2					
61	p50	O	H	In		P LOGIC 2 (NO USE)
62	p51	O	H	In		P LOGIC 3 (NO USE)
63	p52	O	H	In		P LOGIC 4 (NO USE)
64	p53	O	H	In		P LOGIC 5 (NO USE)

High : High-impedance status

In : Input status

• IC304 (LV100M)

Pin No.	Explanations
1	De-couple capacitor for threshold voltage
2, 64	Capacitor for smoothing of rectifier output
3	Capacitor for sliding band filter and Delayed output
4, 62	Capacitor for sliding band filter
5, 61	Capacitor for pre-emphasis
6, 60	Input filter for rectifier
7, 57	Input filter for rectifier
8	Reference voltage
9	Reference voltage
10	Mute control
11	V _{cc}
12	Output for V _{DD}
13	Clock input for serial input, data input for parallel input mode
14	Data input for serial input, data input for parallel input mode
15	Column address selection for serial input, data input for parallel input mode
16	Row address selection for serial input, data input for parallel input mode
18 to 32	Connection to memory device
24	V _{ss}
33	X'tal resonator for oscillator
34	X'tal resonator for oscillator
35	Long or Short mode selection
36	Serial or Parallal mode selection
37	For test mode
38	Smoothing for NR rectifier
39	Smoothing for NR rectifier
40	Capacitor for weighting on side chain path
41	Input for variable resistor
42	NR output
43	7kHz low pass filter output
44	Input for NR
45	Capacitor for de-couple on NR
46	Delay output or NR output
47	Input for mute circuit
48	Output for mute circuit
49	Output for 7kHz low pass filter
50	Input for 7kHz low pass filter
51	GND
52	Input for right channel
53	Input for left channel
54	Capacitor for de-couple on Fixed matrix output
55	Noise shaping and delay input
56	Noise shaping output
57	Delay input signal mode select switch (L + R/L - R)
58	Filter for supply voltage on comparator
63	Capacitor for sliding band filter and local decoder output

Input Address Port Timing
SHORT MODE

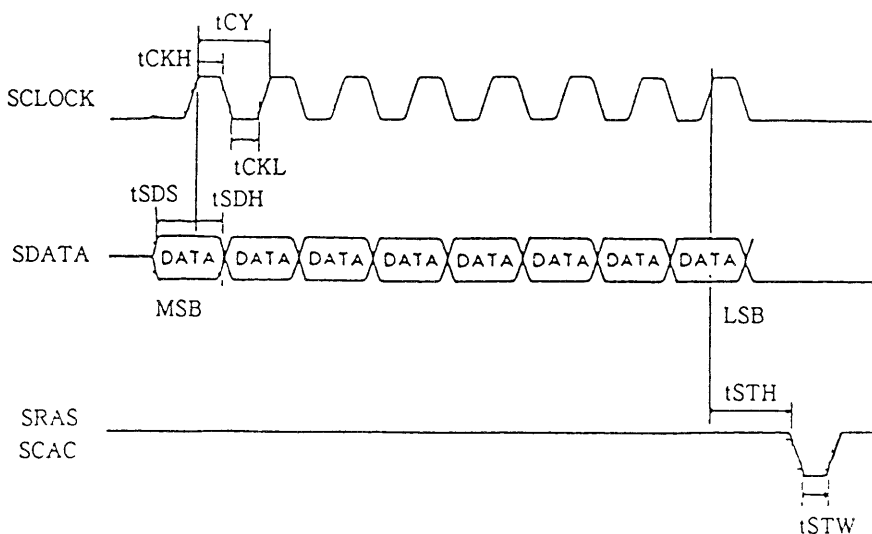

In case of short mode, delay time setting is set in above timing. The data loaded to SDATA is written on the leading edge timing. In order to select that the data latch for row address strobe or column address strobe is loaded, SRAS or SCAS port is controlled.

When changing delay time setting, meaningless data on a memory are read. this causes the pop noise. when SRAS or SCAS is controlled, mute circuit (pin 55 is input, pin 56 is output) is activated. Mute time is the same as the delay time which is set at that time. (Serial data input mode only, On parallel data input mode, mute circuit is activated by using the mute control port pin 18.)

On long mode, input data number is 9, the way of setting delay time is same.

2-3. CIRCUIT BOARDS LOCATION

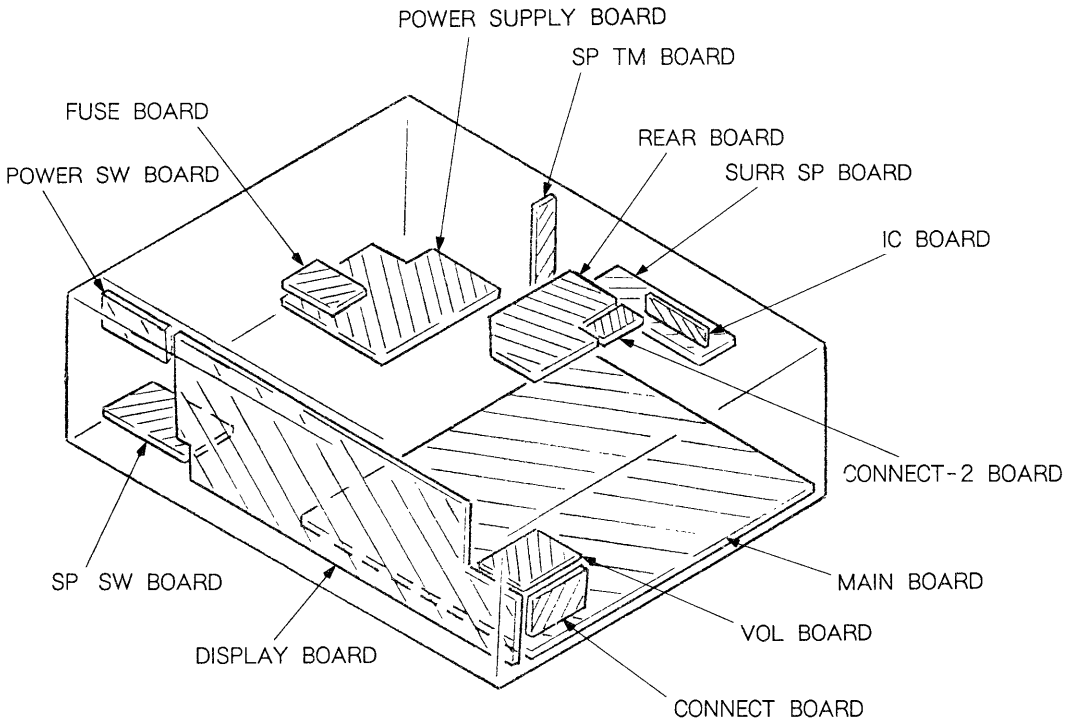

2-4. PRINTED WIRING BOARDS • See page 11 for Circuit Boards Location. • See page 23 for Semiconductor Lead Layouts.

Ref. No.	Location	Ref. No.	Location
D101	H-20	IC956	D-16
D102	I-20		
D103	I-18	Q101	J-18
D104	I-19	Q103	H-19
D105	I-18	Q104	H-19
D106	I-18	Q105	H-24
D107	I-18	Q106	H-24
D111	H-18	Q110	J-24
D112	I-17	Q111	I-25
D113	I-17	Q112	I-25
D701	B-11	Q301	G-6
D702	C-12	Q302	G-6
D703	C-10	Q303	I-9
D704	C-10	Q304	I-9
D705	D-9	Q305	H-9
D706	D-9	Q401	D-12
D707	D-5	Q431	F-24
D751	B-6	Q432	F-26
D752	C-6	Q433	G-27
D753	C-6	Q461	C-28
D754	D-5	Q462	G-28
D801	D-19	Q463	G-27
D802	D-20	Q701	C-11
D803	D-18	Q702	C-11
D911	B-30	Q703	C-11
D912	B-30	Q704	C-12
D913	B-30	Q705	B-10
D914	B-30	Q706	A-11
D915	B-30	Q707	B-12
D916	B-30	Q708	B-10
D917	C-30	Q709	B-11
D918	C-30	Q710	B-10
D919	C-30	Q711	B-12
D920	B-31	Q712	A-10
D951	B-8	Q713	A-12
D952	B-3	Q714	C-10
D953	D-4	Q716	E-7
D954	D-4	Q718	D-9
D955	D-4	Q719	F-6
D956	D-4	Q720	F-6
D957	C-5	Q721	F-6
D959	D-3	Q751	C-5
		Q752	C-5
		Q753	C-5
IC101	I-20	Q754	C-6
IC102	I-18	Q755	C-4
IC301	H-6	Q756	A-6
IC302	G-6	Q757	B-6
IC304	G-8	Q758	B-5
IC305	F-9	Q759	B-5
IC306	I-9	Q760	B-4
IC307	F-11	Q761	B-6
IC401	E-11	Q762	A-6
IC402	D-11	Q763	A-7
IC403	J-22	Q764	C-5
IC431	G-25	Q801	D-19
IC501	I-4	Q911	D-30
IC502	G-4	Q912	B-31
IC701	D-6	Q923	C-30
IC801	E-18	Q923	C-30
IC951	F-4	Q924	C-30
IC952	F-5	Q925	D-30
IC953	D-14	Q926	D-30
IC954	F-5	Q951	C-5
IC955	F-6	Q953	D-2

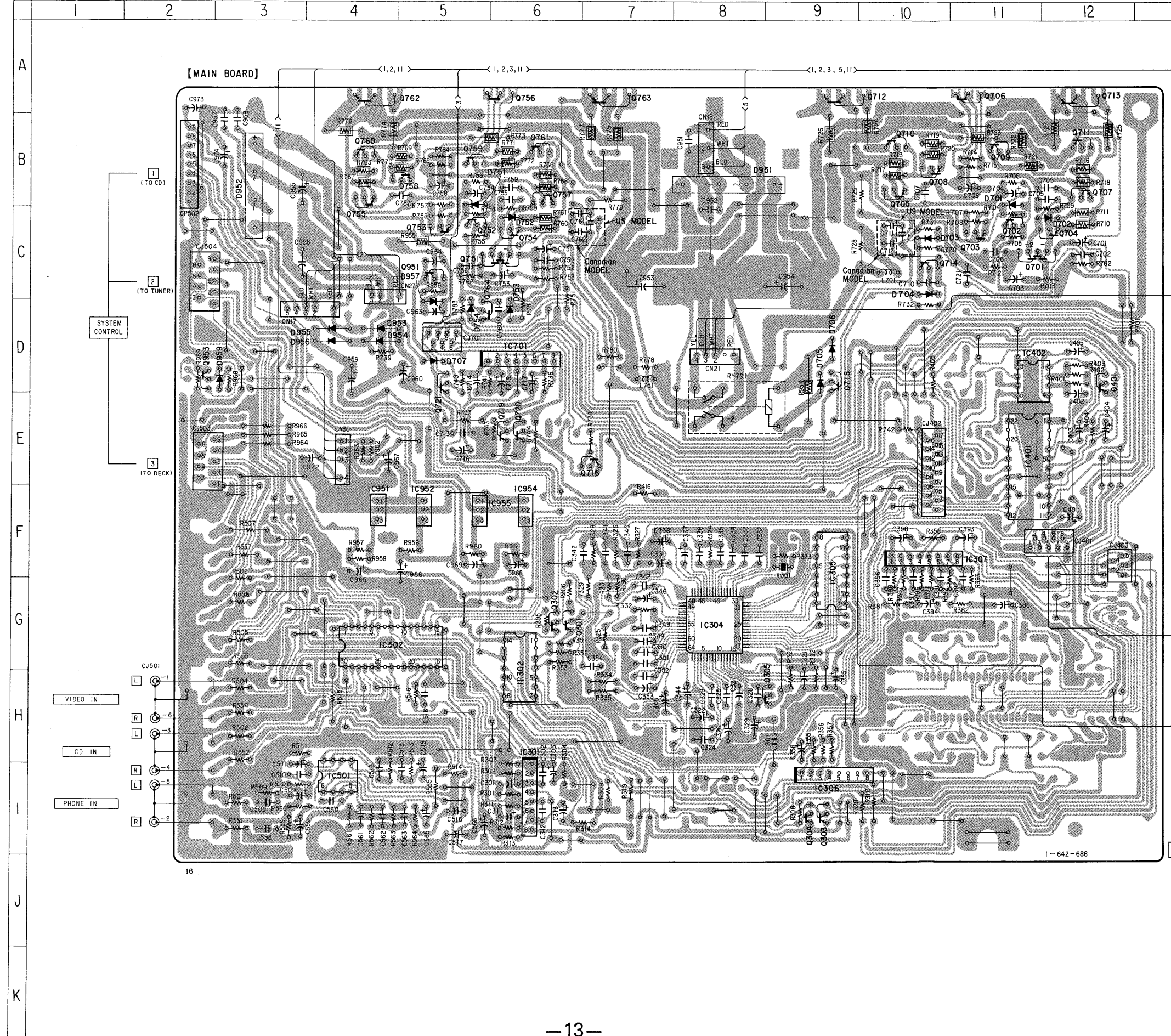

Note on Mounting Diagram :

- : Parts extracted from the component side.
- : Jumper wire connected to the ground pattern on the component side.
- ⏏ : Pattern on the side which is seen.

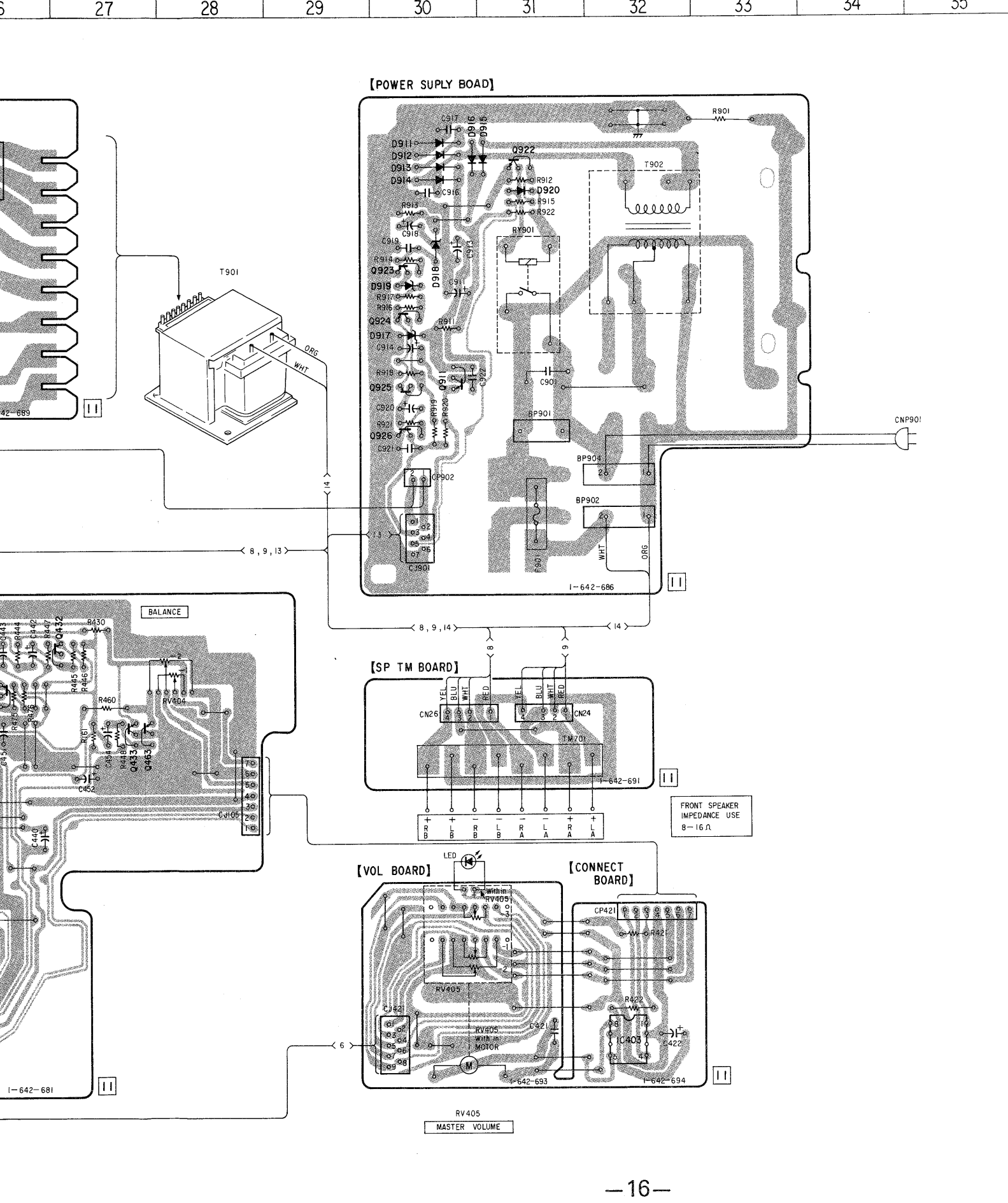
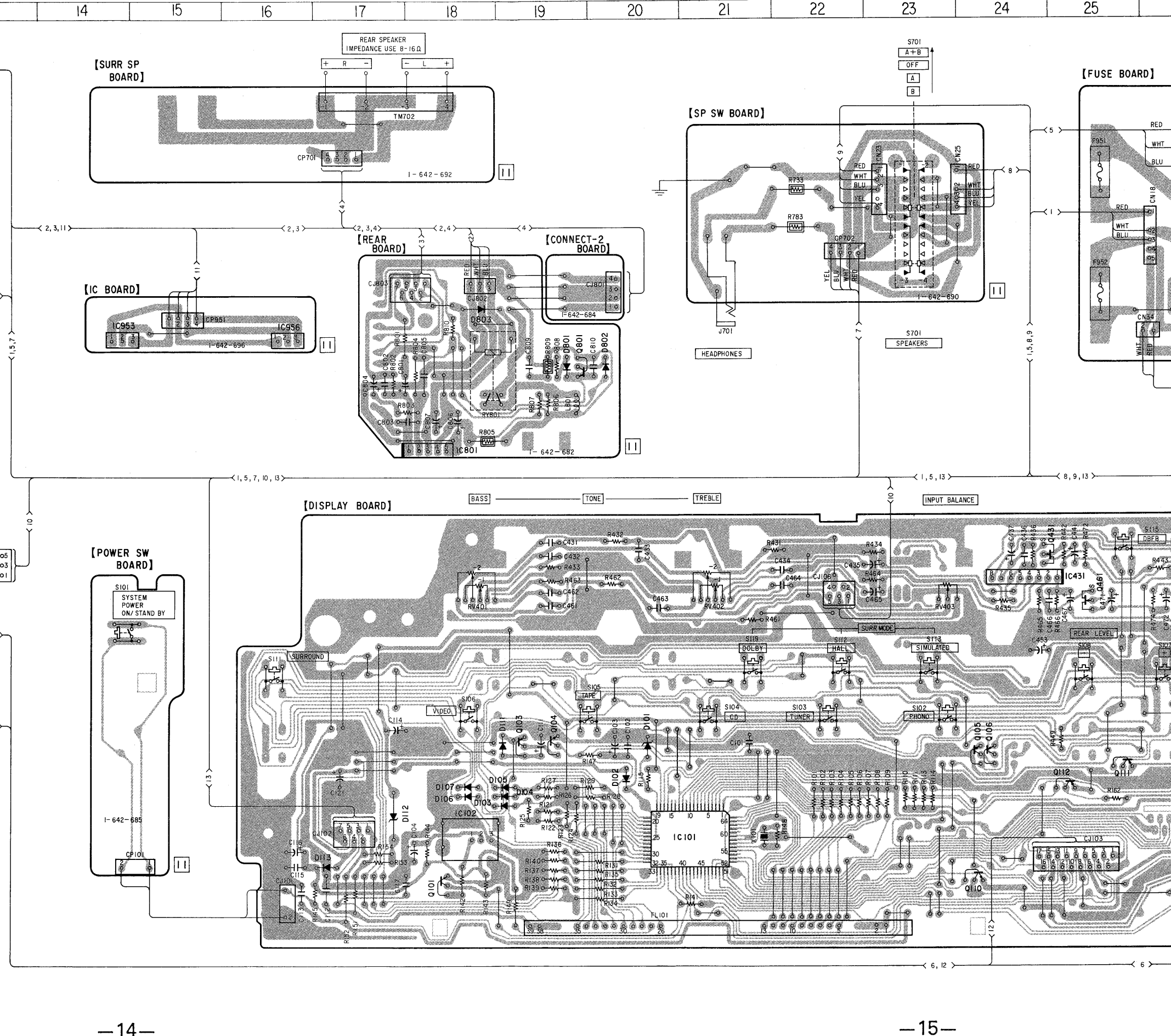

2-5. SCHEMATIC DIAGRAM—MAIN SECTION— See page 9 for IC Description. See page 24 for IC Block Diagrams.

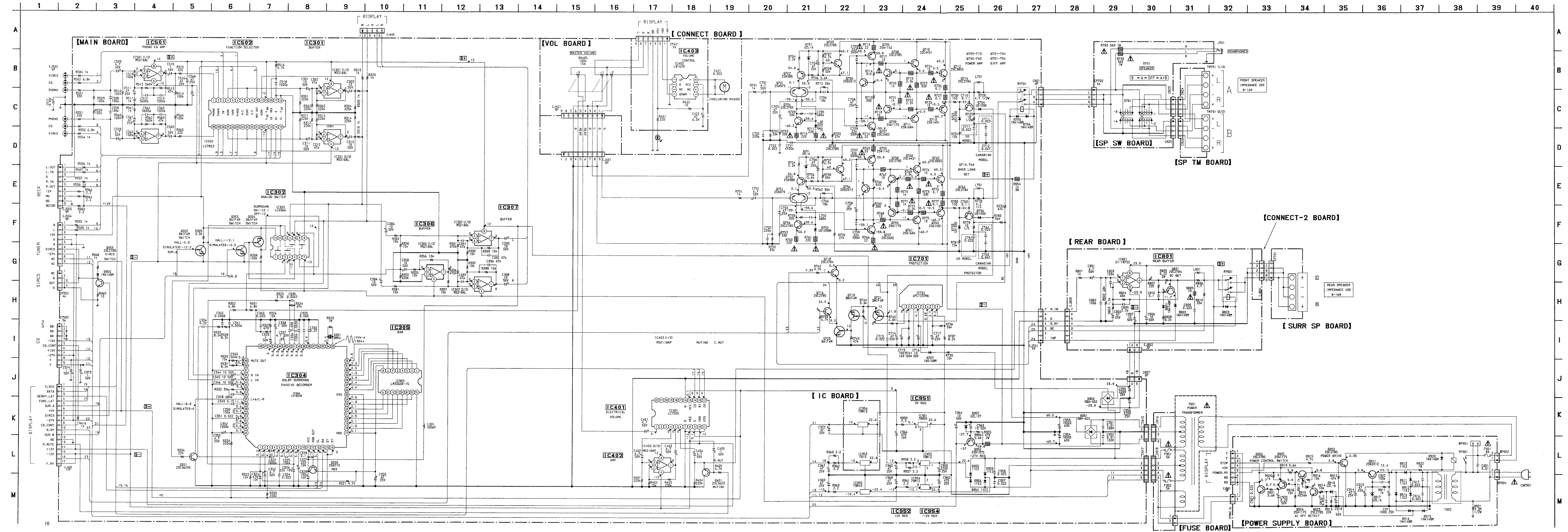

Note on Schematic Diagram :

- All capacitors are in μF unless otherwise noted. pF: μF 50WV or less are not indicated except for electrolytics and tantalums.
- All resistors are in Ω and $\frac{1}{2}$ W or less unless otherwise specified.
- \square : nonflammable resistor.

Note: The components identified by mark Δ or dotted line with mark Δ are critical for safety. Replace only with part number specified.

- \square B+ : B + Line
- \square B- : B - Line
- Voltage and waveforms are dc with respect to ground under no-signal conditions.
- no mark : PHONO
- Voltages are taken with a VOM (input impedance 10 M Ω).
- Voltage variations may be noted due to normal production tolerances.
- Signal path.
- \Rightarrow : PHONO

2-6. SCHEMATIC DIAGRAM—POWER SECTION— • See page 7 for IC Description. • See page 20 for Note.

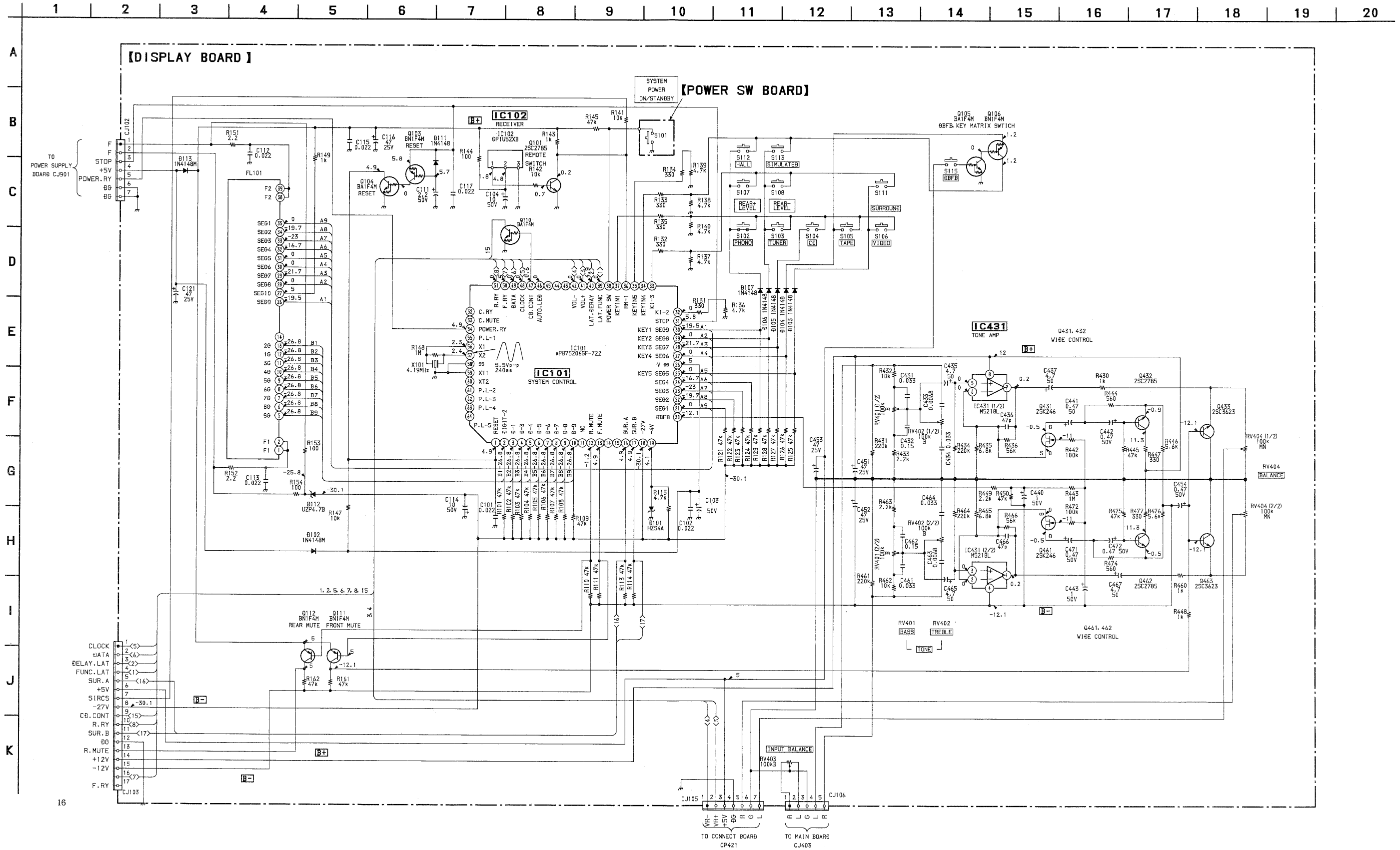

2-7. SEMICONDUCTOR LEAD LAYOUTS

GP1U52XB

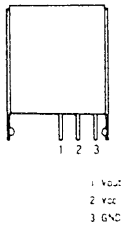

μ PD75206GF-722-3BE

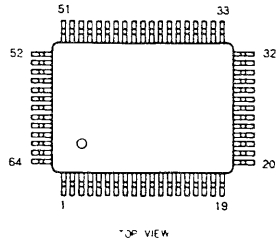

2SA979-FG

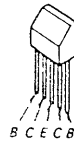

HZS6C3L
UZL-27H
11ES2

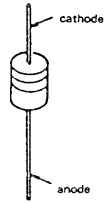

2SA988-PAFAEA



RBV-602-01

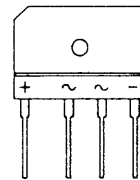

LV1001M

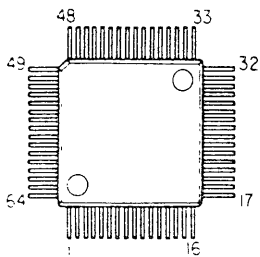

DTA124ES
2SA1175-HFE
2SC2784-F
2SC2785-HFE
2SC3623A-LK

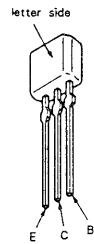

2SB1094-LK
2SD2012

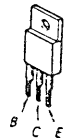

UZP-4.7B

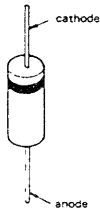

M5F78M05
M5F7810

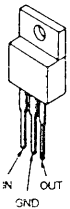

DTC124ES



2SD773-34



M5F79M10
M5F79M12

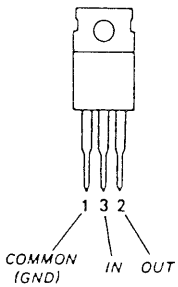

2SA1142-QPE
2SC2682-QPE

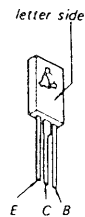

2SK246-Y



HZ4ALL
1N4148M
1S1585

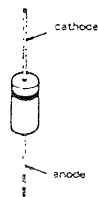

SI18752

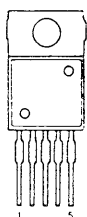

2SA1684-LK
2SC4431-LK

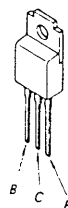

SECTION 3 EXPLODED VIEWS

NOTE:

- -XX, -X mean standardized parts, so they may have some differences from the original one.
- Color Indication of Appearance Parts
Example :
KNOB, BALANCE (WHITE)...(RED)
 ↑ ↑
 Parts color Cabinet's color

- Items marked "*" are not stocked since they are seldom required for routine service. Some delay should be anticipated when ordering these items.
- The mechanical parts with no reference number in the exploded views are not supplied.
- Hardware (# mark) list is given in the last of this parts list.

The components identified by mark or dotted line with mark are critical for safety. Replace only with part number specified.

Les composants identifiés par une marque sont critiques pour la sécurité. Ne les remplacer que par une pièce portant le numéro spécifié.

3-1. OVERALL SECTION 1

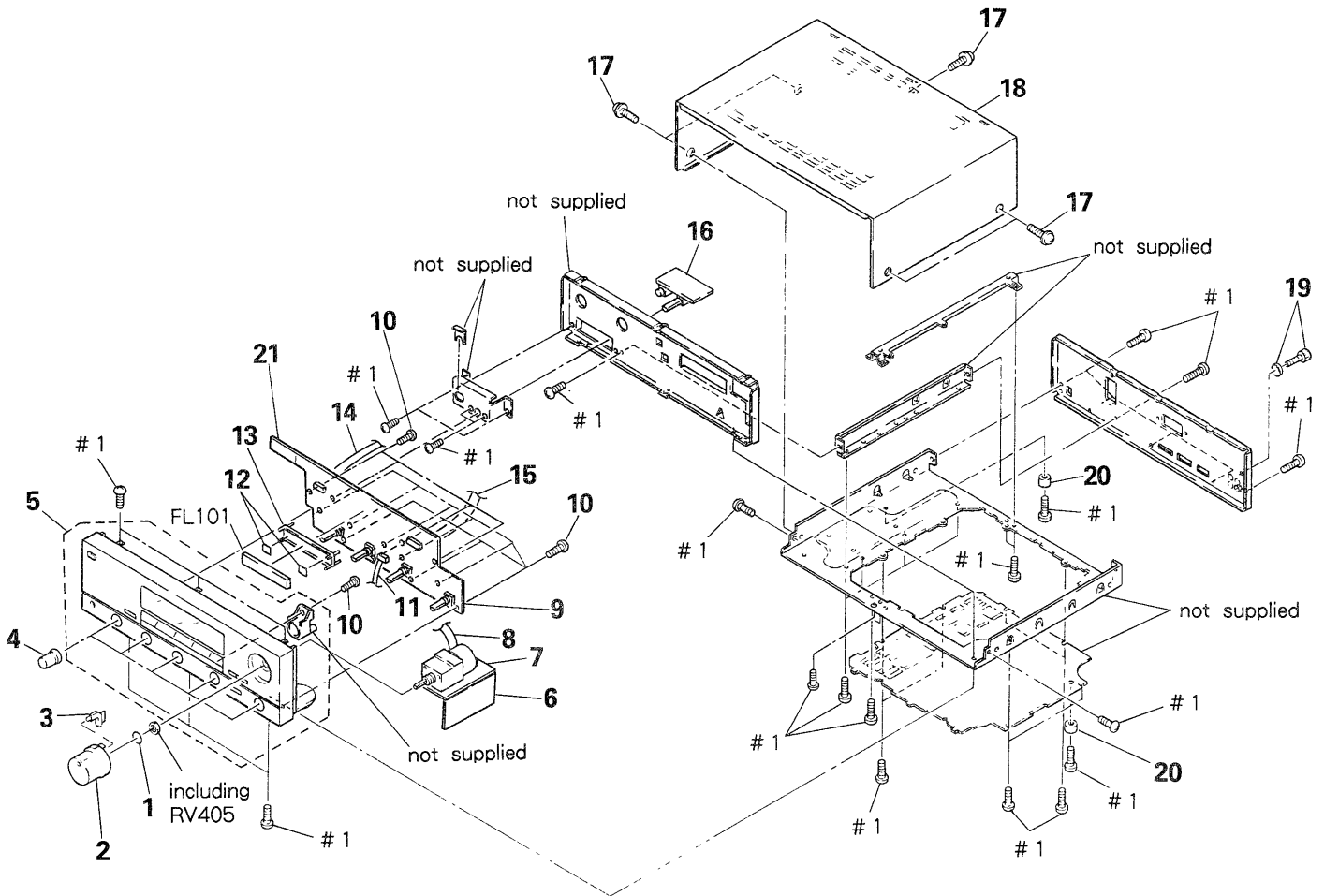

Ref. No.	Part No.	Description
1	3-350-426-01	SPRING, RING
2	4-949-659-01	KNOB (VOL-NEW)
3	4-943-092-01	PLATE(VOL), LIGHT GUIDE
4	4-949-640-01	KNOB (DIA. 21)
5	A-4325-426-A	PANEL ASSY, FRONT (US)
5	A-4325-427-A	PANEL ASSY, FRONT (Canadian)
* 6	1-642-694-11	CONNECT BOARD
* 7	1-642-693-11	VOL BOARD
8	1-690-588-31	WIRE, FLAT TYPE (9 CORE)
* 9	A-4347-048-A	DISPLAY BOARD, COMPLETE
10	4-928-635-01	SCREW, +BV (2.6X8) TAPPING
11	1-575-666-11	WIRE, FLAT TYPE (5 CORE)

Remarks

Ref. No.	Part No.	Description	Remarks
* 12	4-921-941-01	CUSHION (FL)	
* 13	4-943-107-01	HOLDER (FL TUBE)	
14	1-690-114-11	WIRE, FLAT TYPE (7 CORE)	
15	1-590-487-11	WIRE, FLAT TYPE (17 CORE)	
* 16	1-642-690-11	SP SW BOARD	
17	3-704-366-01	SCREW (CASE) (M3X8)	
18	4-931-031-11	CASE	
19	3-706-165-00	SCREW	
20	X-4941-229-1	FOOT ASSY (F2112S-M)	
* 21	1-642-685-11	POWER SW BOARD	
FL101	1-519-663-11	INDICATOR TUBE, FLUORESCENT	

3-2. OVERALL SECTION 2

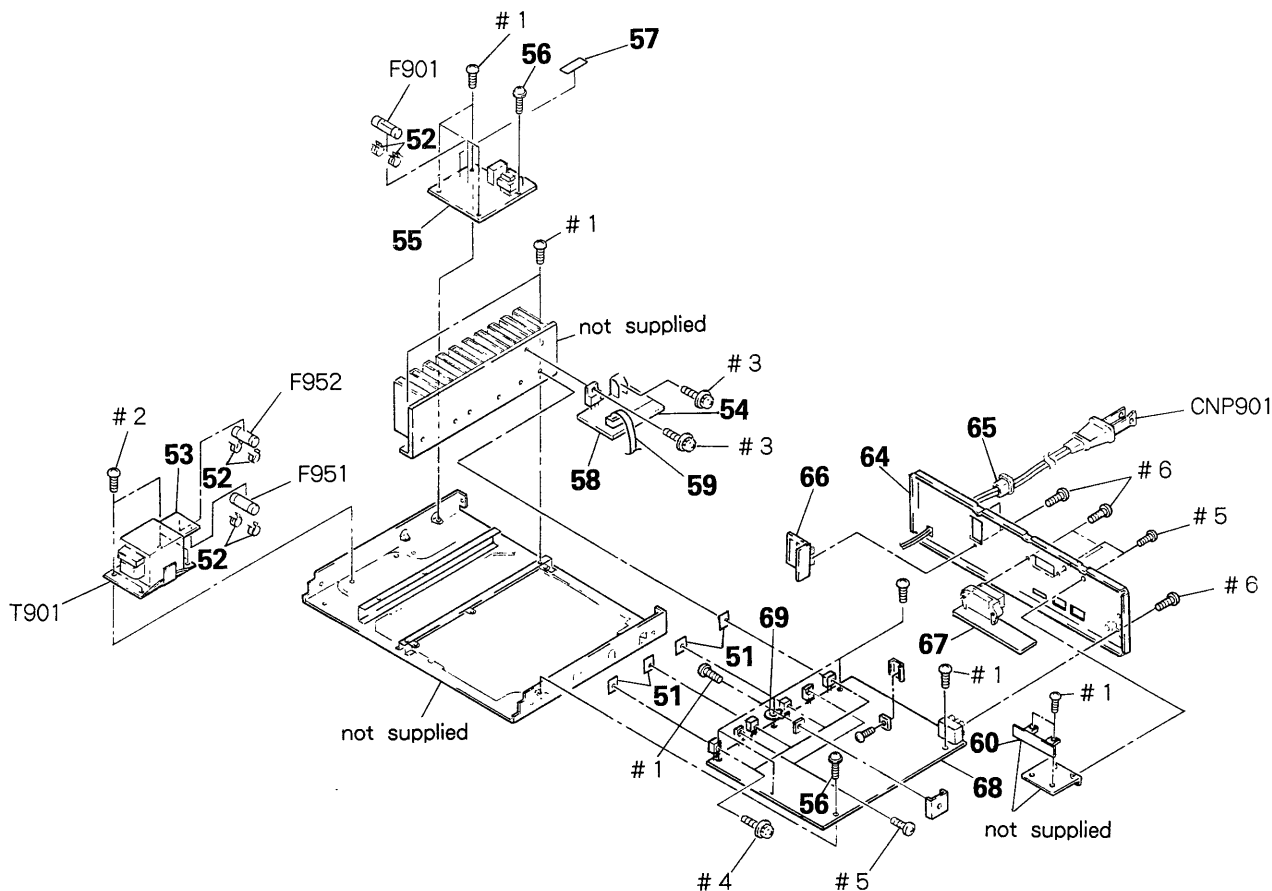

Ref. No.	Part No.	Description	Remarks
51	4-911-232-01	SHEET, INSULATING	
52	1-533-217-31	HOLDER, FUSE	
* 53	1-642-689-11	FUSE BOARD	
* 54	1-642-684-11	CONNECT-2 BOARD	
* 55	A-4347-051-A	POWER SUPP BOARD, COMPLETE	
56	2-383-566-00	SCREW	
* 57	3-701-946-28	LABEL (6.3A125V), FUSE (Canadian)	
* 57	4-949-520-20	LABEL (T4AL) FUSE	
* 58	1-642-682-11	REAR BOARD	
59	1-590-241-11	WIRE, FLAT TYPE (7 CORE)	
* 60	1-642-698-11	IC BOARD	
* 64	4-949-769-01	PANEL, BACK (US)	

Ref. No.	Part No.	Description	Remarks
* 64	4-949-769-11	PANEL, BACK (Canadian)	
65	3-703-244-00	BUSHING (2104), CORD	
* 66	1-642-691-11	SP TM BOARD	
* 67	1-642-692-11	SURR SP BOARD	
* 68	A-4347-042-A	MAIN BOARD, COMPLETE (US)	
* 68	A-4347-052-A	MAIN BOARD, COMPLETE (Canadian)	
* 69	4-942-204-01	PLATE, GROUND	
△CNP901	1-551-478-00	CORD, POWER	
△F901	1-532-748-11	FUSE, GLASS TUBE 6.3A 125V (Canadian)	
△F901	1-532-749-11	FUSE, GLASS TUBE 8A (US)	
△F951	1-576-109-11	FUSE 5A 125V	
△F952	1-576-109-11	FUSE 5A 152V	
△T901	1-450-806-11	TRANSFORMER, POWER	

<p>Note: The components identified by mark Δ or dotted line with mark Δ are critical for safety. Replace only with part number specified.</p>	<p>Note: Les composants identifiés par une marque Δ sont critiques pour la sécurité. Ne les remplacer que par une pièce portant le numéro spécifié.</p>
--	--

CONNECT **CONNECT-2**
DISPLAY

SECTION 4
ELECTRICAL PARTS LIST

NOTE:

The components identified by mark Δ or dotted line with mark Δ are critical for safety. Replace only with part number specified.

Les composants identifiés par une marque Δ sont critiques pour la sécurité. Ne les remplacer que par une pièce portant le numéro spéci-fie.

When indicating parts by reference number, please include the board name.

- Due to standardization, replacements in the parts list may be different from the parts specified in the diagrams or the components used on the set.
- -XX, -X mean standardized parts, so they may have some difference from the original one.
- RESISTORS
 All resistors are in ohms.
 METAL : metal-film resistor
 METAL OXIDE : Metal Oxide-film resistor
 F : nonflammable
- Items marked "*" are not stocked since they are seldom required for routine service. Some delay should be anticipated when ordering these items.
- SEMICONDUCTORS
 In each case, u : μ , for example :
 uA... : μ A..., uPA..., μ PA...,
 uPB..., μ PB..., uPC..., μ PC...,
 uPD..., μ PD...
- CAPACITORS :
 uF : μ F
- COILS :
 uH : μ H

Ref. No.	Part No.	Description	Remarks
*	1-642-694-11	CONNECT BOARD *****	
		< CAPACITOR >	
C422	1-126-154-11	ELECT 47uF 20% 6.3V	
		< CONNECTOR >	
CP421	1-569-132-11	PIN, CONNECTOR 7P	
		< RESISTOR >	
R421	1-249-409-11	CARBON 220 5% 1/4W	
R422	1-249-393-11	CARBON 10 5% 1/4W	

*	1-642-684-11	CONNECT-2 BOARD *****	
		< CONNECTOR >	
CJ801	1-562-087-00	SOCKET, CONNECTOR 4P	

*	A-4347-048-A	DISPLAY BOARD, COMPLETE *****	
	1-533-217-31	HOLDER, FUSE	
*	4-921-941-01	CUSHION (FL)	
*	4-943-107-01	HOLDER (FL TUBE)	
		< CAPACITOR >	
C101	1-164-097-11	CERAMIC 0.022uF 50V	
C102	1-164-097-11	CERAMIC 0.022uF 50V	
C103	1-124-903-11	ELECT 1uF 20% 50V	
C104	1-124-907-11	ELECT 10uF 20% 50V	
C111	1-124-925-11	ELECT 2.2uF 20% 100V	

Ref. No.	Part No.	Description	Remarks
C112	1-164-097-11	CERAMIC 0.022uF 50V	
C113	1-164-097-11	CERAMIC 0.022uF 50V	
C114	1-124-907-11	ELECT 10uF 20% 50V	
C115	1-164-097-11	CERAMIC 0.022uF 50V	
C116	1-124-477-11	ELECT 47uF 20% 25V	
C117	1-164-097-11	CERAMIC 0.022uF 50V	
C121	1-124-477-11	ELECT 47uF 20% 25V	
C431	1-130-489-00	MYLAR 0.033uF 5% 50V	
C432	1-136-167-00	FILM 0.15uF 5% 50V	
C433	1-130-481-00	MYLAR 0.0068uF 5% 50V	
C434	1-130-489-00	MYLAR 0.033uF 5% 50V	
C435	1-124-927-11	ELECT 4.7uF 20% 100V	
C436	1-162-215-31	CERAMIC 47PF 5% 50V	
C437	1-124-927-11	ELECT 4.7uF 20% 100V	
C440	1-124-903-11	ELECT 1uF 20% 50V	
C441	1-124-902-00	ELECT 0.47uF 20% 50V	
C442	1-124-902-00	ELECT 0.47uF 20% 50V	
C443	1-124-903-11	ELECT 1uF 20% 50V	
C451	1-124-477-11	ELECT 47uF 20% 25V	
C452	1-124-477-11	ELECT 47uF 20% 25V	
C453	1-124-477-11	ELECT 47uF 20% 25V	
C454	1-124-902-00	ELECT 0.47uF 20% 50V	
C461	1-130-489-00	MYLAR 0.033uF 5% 50V	
C462	1-136-167-00	FILM 0.15uF 5% 50V	
C463	1-130-481-00	MYLAR 0.0068uF 5% 50V	
C464	1-130-489-00	MYLAR 0.033uF 5% 50V	
C465	1-124-927-11	ELECT 4.7uF 20% 100V	
C466	1-162-215-31	CERAMIC 47PF 5% 50V	
C467	1-124-927-11	ELECT 4.7uF 20% 100V	
C471	1-124-902-00	ELECT 0.47uF 20% 50V	
C472	1-124-902-00	ELECT 0.47uF 20% 50V	
		< CONNECTOR >	
* CJ101	1-565-480-11	CONNECTOR, BOARD TO BOARD 4P	
CJ102	1-691-644-11	SOCKET, CONNECTOR 7P	
CJ103	1-691-649-11	SOCKET, CONNECTOR 17P	
* CJ105	1-561-651-00	SOCKET, CONNECTOR 7P	
* CJ106	1-568-824-11	SOCKET, CONNECTOR 5P	

DISPLAY

Ref. No.	Part No.	Description	Remarks	Ref. No.	Part No.	Description	Remarks
< DIODE >				R111	1-249-437-11	CARBON	47K 5% 1/4W
D101	8-719-985-53	DIODE HZS4ALL		R113	1-249-437-11	CARBON	47K 5% 1/4W
D102	8-719-987-63	DIODE 1N4148M		R114	1-249-437-11	CARBON	47K 5% 1/4W
D103	8-719-987-63	DIODE 1N4148M		R115	1-249-425-11	CARBON	4.7K 5% 1/4W
D104	8-719-987-63	DIODE 1N4148M		R121	1-249-437-11	CARBON	47K 5% 1/4W
D105	8-719-987-63	DIODE 1N4148M		R122	1-249-437-11	CARBON	47K 5% 1/4W
D106	8-719-987-63	DIODE 1N4148M		R123	1-249-437-11	CARBON	47K 5% 1/4W
D107	8-719-987-63	DIODE 1N4148M		R124	1-249-437-11	CARBON	47K 5% 1/4W
D111	8-719-987-63	DIODE 1N4148M		R125	1-249-437-11	CARBON	47K 5% 1/4W
D112	8-719-014-48	DIODE UZP-4.7B		R126	1-249-437-11	CARBON	47K 5% 1/4W
D113	8-719-987-63	DIODE 1N4148M		R127	1-249-437-11	CARBON	47K 5% 1/4W
< FILTER >				R128	1-249-437-11	CARBON	47K 5% 1/4W
FL101	1-519-663-11	INDICATOR TUBE, FLUORESCENT		R129	1-249-437-11	CARBON	47K 5% 1/4W
< IC >				R131	1-249-411-11	CARBON	330 5% 1/4W
IC101	8-759-062-41	IC μ PD75206GF-722-3BE		R132	1-249-411-11	CARBON	330 5% 1/4W
IC102	8-749-920-83	IC GPIU52XB		R133	1-249-411-11	CARBON	330 5% 1/4W
IC431	8-759-634-50	IC M5218AL		R134	1-249-411-11	CARBON	330 5% 1/4W
< TRANSISTOR >				R135	1-249-411-11	CARBON	330 5% 1/4W
Q101	8-729-119-78	TRANSISTOR 2SC2785-HFE		R136	1-249-425-11	CARBON	4.7K 5% 1/4W
Q103	8-729-900-63	TRANSISTOR DTA124ES		R137	1-249-425-11	CARBON	4.7K 5% 1/4W
Q104	8-729-900-36	TRANSISTOR DTC124ES		R138	1-249-425-11	CARBON	4.7K 5% 1/4W
Q105	8-729-900-36	TRANSISTOR DTC124ES		R139	1-249-425-11	CARBON	4.7K 5% 1/4W
Q106	8-729-900-63	TRANSISTOR DTA124ES		R140	1-249-425-11	CARBON	4.7K 5% 1/4W
Q110	8-729-900-36	TRANSISTOR DTC124ES		R141	1-249-429-11	CARBON	10K 5% 1/4W
Q111	8-729-900-63	TRANSISTOR DTA124ES		R142	1-249-429-11	CARBON	10K 5% 1/4W
Q112	8-729-900-63	TRANSISTOR DTA124ES		R143	1-249-417-11	CARBON	1K 5% 1/4W
Q431	8-729-224-61	TRANSISTOR 2SK246-Y		R144	1-249-405-11	CARBON	100 5% 1/4W
Q432	8-729-119-78	TRANSISTOR 2SC2785-HFE		R145	1-249-437-11	CARBON	47K 5% 1/4W
Q433	8-729-141-30	TRANSISTOR 2SC3623A-LK		R147	1-249-429-11	CARBON	10K 5% 1/4W
Q461	8-729-224-61	TRANSISTOR 2SK246-Y		R148	1-247-903-00	CARBON	1M 5% 1/4W
Q462	8-729-119-78	TRANSISTOR 2SC2785-HFE		R149	1-249-417-11	CARBON	1K 5% 1/4W
Q463	8-729-141-30	TRANSISTOR 2SC3623A-LK		R151	1-249-385-11	CARBON	2.2 5% 1/6W
< RESISTOR >				R152	1-249-385-11	CARBON	2.2 5% 1/6W
R101	1-249-437-11	CARBON	47K 5% 1/4W	R153	1-249-405-11	CARBON	100 5% 1/4W
R102	1-249-437-11	CARBON	47K 5% 1/4W	R154	1-249-405-11	CARBON	100 5% 1/4W
R103	1-249-437-11	CARBON	47K 5% 1/4W	R161	1-249-437-11	CARBON	47K 5% 1/4W
R104	1-249-437-11	CARBON	47K 5% 1/4W	R162	1-249-437-11	CARBON	47K 5% 1/4W
R105	1-249-437-11	CARBON	47K 5% 1/4W	R430	1-249-417-11	CARBON	1K 5% 1/4W
R106	1-249-437-11	CARBON	47K 5% 1/4W	R431	1-247-887-00	CARBON	220K 5% 1/4W
R107	1-249-437-11	CARBON	47K 5% 1/4W	R432	1-249-429-11	CARBON	10K 5% 1/4W
R108	1-249-437-11	CARBON	47K 5% 1/4W	R433	1-249-421-11	CARBON	2.2K 5% 1/4W
R109	1-249-437-11	CARBON	47K 5% 1/4W	R434	1-247-887-00	CARBON	220K 5% 1/4W
R110	1-249-437-11	CARBON	47K 5% 1/4W	R435	1-249-427-11	CARBON	6.8K 5% 1/4W
				R436	1-249-438-11	CARBON	56K 5% 1/4W
				R442	1-249-441-11	CARBON	100K 5% 1/4W
				R443	1-247-903-00	CARBON	1M 5% 1/4W
				R444	1-249-414-11	CARBON	560 5% 1/4W
				R445	1-249-437-11	CARBON	47K 5% 1/4W
				R446	1-249-426-11	CARBON	5.6K 5% 1/4W
				R447	1-249-411-11	CARBON	330 5% 1/4W

DISPLAY	FUSE	IC	MAIN
---------	------	----	------

Ref. No.	Part No.	Description	Remarks
R806	1-249-389-11	CARBON 4.7 5% 1/4W	
R807	1-249-409-11	CARBON 220 5% 1/4W	
R808	1-249-428-11	CARBON 8.2K 5% 1/4W	
△R809	1-249-393-11	CARBON 10 5% 1/4W	
R810	1-249-435-11	CARBON 33K 5% 1/4W	
< RELAY >			
RY801	1-515-790-11	RELAY	

*	1-642-690-11	SP SW BOARD	

< CONNECTOR >			
* CP702	1-564-778-11	PLUG, CONNECTOR (2.5MM) 4P	
< JACK >			
J701	1-563-347-11	JACK, LARGE TYPE	
< RESISTOR >			
△R733	1-216-431-11	METAL OXIDE 560 5% 1W F	
△R783	1-216-431-11	METAL OXIDE 560 5% 1W F	
< SWITCH >			
S701	1-572-812-11	SWITCH, ROTARY SLIDE (SPEAKERS)	

*	1-642-691-11	SP TM BOARD	

< TERMINAL >			
TM701	1-537-341-11	TERMINAL BOARD (8P SP) (FRONT SPEAKER)	

*	1-642-692-11	SURR SP BOARD	

< CONNECTOR >			
* CP701	1-506-509-11	PIN, CONNECTOR 4P	
< TERMINAL >			
TM702	1-537-265-31	TERMINAL BOARD (REAR SPEAKER)	

Ref. No.	Part No.	Description	Remarks
*	1-642-693-11	VOL BOARD	

< CAPACITOR >			
C421	1-164-097-11	CERAMIC 0.022uF	50V
< CONNECTOR >			
* CJ421	1-568-828-11	SOCKET, CONNECTOR 9P	
< VARIABLE RESISTOR >			
RV405	1-241-816-11	RES, VAR, CARBON 100KX4 (MASTER VOLUME)	

MISCELLANEOUS			

11	1-575-666-11	WIRE, FLAT TYPE (5 CORE)	
14	1-690-114-11	WIRE, FLAT TYPE (7 CORE)	
15	1-590-487-11	WIRE, FLAT TYPE (17 CORE)	
59	1-590-241-11	WIRE, FLAT TYPE (7 CORE)	
8	1-690-588-31	WIRE, FLAT TYPE (9 CORE)	
△CNP901	1-551-478-00	CORD, POWER	
FL101	1-519-663-11	INDICATOR TUBE, FLUORESCENT	
△T901	1-450-806-11	TRANSFORMER, POWER	

ACCESSORIES & PACKING MATERIALS			

1-693-023-11 COMMANDER (STANDARD) (RM-U521)			
3-707-584-31 COVER, BATTERY			
3-754-877-21 MANUAL, INSTRUCTION (ENGLISH)			
*	4-949-866-02 INDIVIDUAL CARTON		
*	4-949-872-01 CUSHION		

HARDWARE LIST			

#1	7-682-548-04	SCREW +BVTT 3X8 (S)	
#2	7-682-561-04	SCREW +BVTT 4X8 (S)	
#3	7-682-950-01	SCREW +PSW 3X12	
#4	7-682-949-01	SCREW +PSW 3X10	
#5	7-682-548-09	SCREW +B 3X8	
#6	7-685-646-79	SCREW +BVTP 3X8 TYPE2 N-S	

<p>Note: The components identified by mark △ or dotted line with mark △ are critical for safety. Replace only with part number specified.</p>	<p>Note: Les composants identifiés par une marque △ sont critiques pour la sécurité. Ne les remplacer que par une pièce portant le numéro spécifié.</p>
--	--

MAIN

Ref. No.	Part No.	Description	Remarks	Ref. No.	Part No.	Description	Remarks
C342	1-102-127-00	CERAMIC	6800PF 10% 50V	C706	1-162-205-31	CERAMIC	18PF 5% 50V
C343	1-162-291-31	CERAMIC	560PF 10% 50V	C707	1-161-959-00	CERAMIC	22PF 10% 500V
C344	1-124-907-11	ELECT	10uF 20% 50V	C708	1-124-477-11	ELECT	47uF 20% 25V
C345	1-124-907-11	ELECT	10uF 20% 50V	C709	1-161-959-00	CERAMIC	22PF 10% 500V
C346	1-124-907-11	ELECT	10uF 20% 50V	C710	1-136-165-00	FILM	0.1uF 5% 50V
C348	1-162-292-31	CERAMIC	680PF 10% 50V	C711	1-130-487-00	MYLAR	0.022uF 5% 50V (US)
C349	1-136-167-00	FILM	0.15uF 5% 50V	C711	1-130-491-00	MYLAR	0.047uF 5% 50V (Canadian)
C350	1-162-284-31	CERAMIC	150PF 10% 50V	C712	1-130-491-00	MYLAR	0.047uF 5% 50V (Canadian)
C351	1-130-487-00	MYLAR	0.022uF 5% 50V	C713	1-164-097-11	CERAMIC	0.022uF 50V
C352	1-162-294-31	CERAMIC	0.001uF 10% 50V	C714	1-124-477-11	ELECT	47uF 20% 25V
C353	1-124-927-11	ELECT	4.7uF 20% 100V	C715	1-126-933-11	ELECT	100uF 20% 16V
C354	1-136-169-00	FILM	0.22uF 5% 50V	C716	1-124-907-11	ELECT	10uF 20% 50V
C355	1-124-477-11	ELECT	47uF 20% 25V	C717	1-124-477-11	ELECT	47uF 20% 25V
C358	1-124-907-11	ELECT	10uF 20% 50V	C721	1-102-125-00	CERAMIC	4700PF 10% 50V
C384	1-124-907-11	ELECT	10uF 20% 50V	C722	1-164-097-11	CERAMIC	0.022uF 50V
C386	1-124-907-11	ELECT	10uF 20% 50V	C751	1-124-927-11	ELECT	4.7uF 20% 100V
C391	1-162-215-31	CERAMIC	47PF 5% 50V	C752	1-162-286-31	CERAMIC	220PF 10% 50V
C392	1-162-215-31	CERAMIC	47PF 5% 50V	C753	1-124-477-11	ELECT	47uF 20% 25V
C393	1-124-907-11	ELECT	10uF 20% 50V	C754	1-124-477-11	ELECT	47uF 20% 25V
C396	1-162-215-31	CERAMIC	47PF 5% 50V	C755	1-162-292-31	CERAMIC	680PF 10% 50V
C397	1-162-215-31	CERAMIC	47PF 5% 50V	C756	1-162-205-31	CERAMIC	18PF 5% 50V
C398	1-124-907-11	ELECT	10uF 20% 50V	C757	1-161-959-00	CERAMIC	22PF 10% 500V
C401	1-124-927-11	ELECT	4.7uF 20% 100V	C758	1-124-477-11	ELECT	47uF 20% 25V
C402	1-124-927-11	ELECT	4.7uF 20% 100V	C759	1-161-959-00	CERAMIC	22PF 10% 500V
C403	1-124-927-11	ELECT	4.7uF 20% 100V	C760	1-136-165-00	FILM	0.1uF 5% 50V
C404	1-124-927-11	ELECT	4.7uF 20% 100V	C761	1-130-487-00	MYLAR	0.022uF 5% 50V (US)
C405	1-124-903-11	ELECT	1uF 20% 50V	C761	1-130-491-00	MYLAR	0.047uF 5% 50V (Canadian)
C508	1-162-282-31	CERAMIC	100PF 10% 50V	C762	1-130-491-00	MYLAR	0.047uF 5% 50V (Canadian)
C509	1-124-927-11	ELECT	4.7uF 20% 100V	C951	1-106-367-00	MYLAR	0.01uF 5% 200V
C510	1-162-282-31	CERAMIC	100PF 10% 50V	C952	1-106-367-00	MYLAR	0.01uF 5% 200V
C511	1-124-477-11	ELECT	47uF 20% 25V	C953	1-125-749-11	ELECT	10000uF 20% 63V
C512	1-102-126-00	CERAMIC	0.0056uF 10% 50V	C954	1-125-749-11	ELECT	10000uF 20% 63V
C513	1-102-119-00	CERAMIC	1500PF 10% 50V	C955	1-124-563-11	ELECT	2200uF 20% 25V
C515	1-124-903-11	ELECT	1uF 20% 50V	C956	1-124-563-11	ELECT	2200uF 20% 25V
C516	1-124-477-11	ELECT	47uF 20% 25V	C957	1-164-097-11	CERAMIC	0.022uF 50V
C517	1-124-907-11	ELECT	10uF 20% 50V	C958	1-164-097-11	CERAMIC	0.022uF 50V
C518	1-162-294-31	CERAMIC	0.001uF 10% 50V	C959	1-124-563-11	ELECT	2200uF 20% 25V
C558	1-162-282-31	CERAMIC	100PF 10% 50V	C960	1-124-480-11	ELECT	470uF 20% 25V
C559	1-124-927-11	ELECT	4.7uF 20% 100V	C963	1-124-907-11	ELECT	10uF 20% 50V
C560	1-162-282-31	CERAMIC	100PF 10% 50V	C964	1-124-907-11	ELECT	10uF 20% 50V
C561	1-124-477-11	ELECT	47uF 20% 25V	C965	1-124-477-11	ELECT	47uF 20% 25V
C562	1-102-126-00	CERAMIC	0.0056uF 10% 50V	C966	1-126-925-11	ELECT	470uF 20% 10V
C563	1-102-119-00	CERAMIC	1500PF 10% 50V	C967	1-124-477-11	ELECT	47uF 20% 25V
C565	1-124-903-11	ELECT	1uF 20% 50V	C968	1-124-477-11	ELECT	47uF 20% 25V
C566	1-124-477-11	ELECT	47uF 20% 25V	C969	1-124-477-11	ELECT	47uF 20% 25V
C701	1-124-927-11	ELECT	4.7uF 20% 100V	C972	1-124-477-11	ELECT	47uF 20% 25V
C702	1-162-286-31	CERAMIC	220PF 10% 50V	C973	1-124-903-11	ELECT	1uF 20% 50V
C703	1-124-477-11	ELECT	47uF 20% 25V	C974	1-124-903-11	ELECT	1uF 20% 50V
C704	1-124-477-11	ELECT	47uF 20% 25V				
C705	1-162-292-31	CERAMIC	680PF 10% 50V				

MAIN

Ref. No.	Part No.	Description	Remarks	Ref. No.	Part No.	Description	Remarks
< CONNECTOR >				< COIL >			
* CJ401	1-568-828-11	SOCKET, CONNECTOR 9P		L301	1-410-521-11	INDUCTOR 100uH	
* CJ402	1-568-836-11	SOCKET, CONNECTOR 17P		L701	1-420-872-00	COIL, AIR CORE	
* CJ403	1-568-824-11	SOCKET, CONNECTOR 5P		L751	1-420-872-00	COIL, AIR CORE	
CJ501	1-580-826-11	JACK, PIN 6P (PHONO/CD/VIDEO IN)		< TRANSISTOR >			
CJ503	1-565-949-11	SOCKET, CONNECTOR 9P (SYSTEM CONTROL 3)		Q301	8-729-141-30	TRANSISTOR 2SC3623A-LK	
CJ504	1-565-949-11	SOCKET, CONNECTOR 9P (SYSTEM CONTROL 2)		Q302	8-729-900-36	TRANSISTOR DTC124ES	
* CJ701	1-568-826-11	SOCKET, CONNECTOR 7P		Q303	8-729-900-36	TRANSISTOR DTC124ES	
CP502	1-691-637-11	PIN, CONNECTOR 9P (SYSTEM CONTROL 1)		Q304	8-729-900-63	TRANSISTOR DTA124ES	
< DIODE >				Q305	8-729-140-98	TRANSISTOR 2SD773	
D701	8-719-933-41	DIODE HZS6C3L		Q401	8-729-141-30	TRANSISTOR 2SC3623A-LK	
D702	8-719-815-85	DIODE 1S1585		Q701	8-729-620-18	TRANSISTOR 2SA979-FG	
D703	8-719-815-85	DIODE 1S1585		Q702	8-729-140-82	TRANSISTOR 2SA988-PAFAEA	
D704	8-719-815-85	DIODE 1S1585		Q703	8-729-119-78	TRANSISTOR 2SC2785-HFE	
D705	8-719-987-63	DIODE 1N4148M		Q704	8-729-119-78	TRANSISTOR 2SC2785-HFE	
D706	8-719-987-63	DIODE 1N4148M		Q705	8-729-141-06	TRANSISTOR 2SA1142-QPE	
D707	8-719-987-63	DIODE 1N4148M		Q706	8-729-209-15	TRANSISTOR 2SD2012	
D751	8-719-933-41	DIODE HZS6C3L		Q707	8-729-141-05	TRANSISTOR 2SC2682-QPE	
D752	8-719-815-85	DIODE 1S1585		Q708	8-729-119-78	TRANSISTOR 2SC2785-HFE	
D753	8-719-815-85	DIODE 1S1585		Q709	8-729-119-76	TRANSISTOR 2SA1175-HFE	
D754	8-719-815-85	DIODE 1S1585		Q710	8-729-141-46	TRANSISTOR 2SC4431-LK	
D951	8-719-302-38	DIODE RBV-602-01		Q711	8-729-141-37	TRANSISTOR 2SA1684-LK	
D952	8-719-312-09	DIODE RBA-402		Q712	8-729-320-83	TRANSISTOR 2SC3855-0Y	
D953	8-719-200-82	DIODE 11ES2		Q713	8-729-320-86	TRANSISTOR 2SA1491-0Y	
D954	8-719-200-82	DIODE 11ES2		Q714	8-729-178-42	TRANSISTOR 2SC2784-F	
D955	8-719-200-82	DIODE 11ES2		Q716	8-729-119-78	TRANSISTOR 2SC2785-HFE	
D956	8-719-200-82	DIODE 11ES2		Q718	8-729-178-42	TRANSISTOR 2SC2784-F	
D957	8-719-002-48	DIODE UZL-27H		Q719	8-729-900-63	TRANSISTOR DTA124ES	
D959	8-719-987-63	DIODE 1N4148M		Q720	8-729-900-36	TRANSISTOR DTC124ES	
< IC >				Q721	8-729-900-63	TRANSISTOR DTA124ES	
IC301	8-759-634-50	IC M5218AL		Q751	8-729-620-18	TRANSISTOR 2SA979-FG	
IC302	8-759-801-01	IC LC4966		Q752	8-729-140-82	TRANSISTOR 2SA988-PAFAEA	
IC304	8-759-823-63	IC LV1001M		Q753	8-729-119-78	TRANSISTOR 2SC2785-HFE	
IC305	8-759-821-13	IC LM3364K-15		Q754	8-729-119-78	TRANSISTOR 2SC2785-HFE	
IC306	8-759-634-50	IC M5218AL		Q755	8-729-141-06	TRANSISTOR 2SA1142-QPE	
IC307	8-759-634-50	IC M5218AL		Q756	8-729-209-15	TRANSISTOR 2SD2012	
IC401	8-759-820-11	IC LC7535		Q757	8-729-141-05	TRANSISTOR 2SC2682-QPE	
IC402	8-759-634-51	IC M5218AP		Q758	8-729-119-78	TRANSISTOR 2SC2785-HFE	
IC403	8-759-820-62	IC LB1639		Q759	8-729-119-76	TRANSISTOR 2SA1175-HFE	
IC501	8-759-634-51	IC M5218AP		Q760	8-729-141-46	TRANSISTOR 2SC4431-LK	
IC502	8-759-805-14	IC LC7822		Q761	8-729-141-37	TRANSISTOR 2SA1684-LK	
IC701	8-759-111-68	IC uPC1237HA (HEADPHONES		Q762	8-729-320-83	TRANSISTOR 2SC3855-0Y	
IC951	8-759-604-39	IC AN6291		Q763	8-729-320-86	TRANSISTOR 2SA1491-0Y	
IC952	8-759-604-35	IC M5F78M05L		Q764	8-729-178-42	TRANSISTOR 2SC2784-F	
IC954	8-759-604-45	IC M5F79M12L		Q951	8-729-141-83	TRANSISTOR 2SB1094-LK	
IC955	8-759-604-44	IC M5F79M10		Q953	8-729-119-78	TRANSISTOR 2SC2785-HFE	

MAIN

Ref. No.	Part No.	Description	Remarks	Ref. No.	Part No.	Description	Remarks
< RESISTOR >							
R301	1-247-887-00	CARBON 220K 5%	1/4W	R416	1-249-417-11	CARBON 1K 5%	1/4W
R302	1-247-887-00	CARBON 220K 5%	1/4W	R501	1-249-411-11	CARBON 330 5%	1/4W
R303	1-247-887-00	CARBON 220K 5%	1/4W	R502	1-249-427-11	CARBON 6.8K 5%	1/4W
R304	1-247-887-00	CARBON 220K 5%	1/4W	R504	1-249-417-11	CARBON 1K 5%	1/4W
R305	1-249-423-11	CARBON 3.3K 5%	1/4W	R505	1-249-417-11	CARBON 1K 5%	1/4W
R306	1-249-433-11	CARBON 22K 5%	1/4W	R506	1-249-417-11	CARBON 1K 5%	1/4W
R308	1-249-441-11	CARBON 100K 5%	1/4W	R507	1-249-417-11	CARBON 1K 5%	1/4W
R309	1-249-417-11	CARBON 1K 5%	1/4W	R509	1-249-441-11	CARBON 100K 5%	1/4W
R310	1-249-417-11	CARBON 1K 5%	1/4W	R510	1-249-441-11	CARBON 100K 5%	1/4W
R311	1-247-887-00	CARBON 220K 5%	1/4W	R511	1-249-417-11	CARBON 1K 5%	1/4W
R312	1-247-887-00	CARBON 220K 5%	1/4W	R512	1-247-897-11	CARBON 560K 5%	1/4W
R313	1-247-887-00	CARBON 220K 5%	1/4W	R513	1-249-437-11	CARBON 47K 5%	1/4W
R314	1-247-887-00	CARBON 220K 5%	1/4W	R514	1-249-441-11	CARBON 100K 5%	1/4W
R319	1-249-417-11	CARBON 1K 5%	1/4W	R515	1-249-409-11	CARBON 220 5%	1/4W
R320	1-249-417-11	CARBON 1K 5%	1/4W	R516	1-249-425-11	CARBON 4.7K 5%	1/4W
R321	1-249-425-11	CARBON 4.7K 5%	1/4W	R551	1-249-411-11	CARBON 330 5%	1/4W
R322	1-249-430-11	CARBON 12K 5%	1/4W	R552	1-249-427-11	CARBON 6.8K 5%	1/4W
R323	1-247-903-00	CARBON 1M 5%	1/4W	R554	1-249-417-11	CARBON 1K 5%	1/4W
R324	1-249-437-11	CARBON 47K 5%	1/4W	R555	1-249-417-11	CARBON 1K 5%	1/4W
R325	1-249-423-11	CARBON 3.3K 5%	1/4W	R556	1-249-417-11	CARBON 1K 5%	1/4W
R326	1-249-429-11	CARBON 10K 5%	1/4W	R557	1-249-417-11	CARBON 1K 5%	1/4W
R327	1-249-413-11	CARBON 470 5%	1/4W	R559	1-249-441-11	CARBON 100K 5%	1/4W
R328	1-249-428-11	CARBON 8.2K 5%	1/4W	R560	1-249-441-11	CARBON 100K 5%	1/4W
R329	1-249-428-11	CARBON 8.2K 5%	1/4W	R561	1-249-417-11	CARBON 1K 5%	1/4W
R330	1-249-431-11	CARBON 15K 5%	1/4W	R562	1-247-897-11	CARBON 560K 5%	1/4W
R331	1-249-428-11	CARBON 8.2K 5%	1/4W	R563	1-249-437-11	CARBON 47K 5%	1/4W
R332	1-249-436-11	CARBON 39K 5%	1/4W	R564	1-249-441-11	CARBON 100K 5%	1/4W
R334	1-247-887-00	CARBON 220K 5%	1/4W	R565	1-249-409-11	CARBON 220 5%	1/4W
R335	1-247-887-00	CARBON 220K 5%	1/4W	R701	1-249-417-11	CARBON 1K 5%	1/4W
R351	1-249-427-11	CARBON 6.8K 5%	1/4W	R702	1-249-435-11	CARBON 33K 5%	1/4W
R352	1-249-427-11	CARBON 6.8K 5%	1/4W	R703	1-249-411-11	CARBON 330 5%	1/4W
R353	1-247-887-00	CARBON 220K 5%	1/4W	R704	1-249-421-11	CARBON 2.2K 5%	1/4W
R355	1-249-429-11	CARBON 10K 5%	1/4W	R705	1-249-434-11	CARBON 27K 5%	1/4W
R356	1-249-429-11	CARBON 10K 5%	1/4W	R706	1-249-426-11	CARBON 5.6K 5%	1/4W
R357	1-249-429-11	CARBON 10K 5%	1/4W	R707	1-249-425-11	CARBON 4.7K 5%	1/4W
R358	1-249-429-11	CARBON 10K 5%	1/4W	R708	1-249-435-11	CARBON 33K 5%	1/4W
R381	1-249-429-11	CARBON 10K 5%	1/4W	R709	1-249-411-11	CARBON 330 5%	1/4W
R382	1-249-429-11	CARBON 10K 5%	1/4W	△R710	1-249-409-11	CARBON 220 5%	1/4W
R391	1-247-895-00	CARBON 470K 5%	1/4W	△R711	1-249-409-11	CARBON 220 5%	1/4W
R392	1-249-429-11	CARBON 10K 5%	1/4W	R712	1-249-435-11	CARBON 33K 5%	1/4W
R393	1-249-429-11	CARBON 10K 5%	1/4W	△R713	1-249-397-11	CARBON 22 5%	1/4W
R396	1-247-895-00	CARBON 470K 5%	1/4W	R714	1-247-830-11	CARBON 910 5%	1/4W
R397	1-249-429-11	CARBON 10K 5%	1/4W	R715	1-249-412-11	CARBON 390 5%	1/4W
R398	1-249-429-11	CARBON 10K 5%	1/4W	△R716	1-249-397-11	CARBON 22 5%	1/4W
R401	1-247-887-00	CARBON 220K 5%	1/4W	△R717	1-249-393-11	CARBON 10 5%	1/4W
R402	1-249-429-11	CARBON 10K 5%	1/4W	△R718	1-249-393-11	CARBON 10 5%	1/4W
R403	1-247-883-00	CARBON 150K 5%	1/4W	△R719	1-249-423-11	CARBON 3.3K 5%	1/4W
R404	1-247-887-00	CARBON 220K 5%	1/4W	△R720	1-249-417-11	CARBON 1K 5%	1/4W
R405	1-249-425-11	CARBON 4.7K 5%	1/4W	△R721	1-249-417-11	CARBON 1K 5%	1/4W
				△R722	1-249-421-11	CARBON 2.2K 5%	1/4W

Note:
The components identified by mark △ or dotted line with mark △ are critical for safety. Replace only with part number specified.

Note:
Les composants identifiés par une marque △ sont critiques pour la sécurité. Ne les remplacer que par une pièce portant le numéro spécifié.

MAIN POWER SUPPLY

Ref. No.	Part No.	Description			
△R723	1-247-706-11	CARBON	330	5%	1/4W
△R724	1-247-688-11	CARBON	10	5%	1/4W
△R725	1-247-688-11	CARBON	10	5%	1/4W
△R726	1-214-789-00	RES, METAL PLATE			0.1
△R727	1-214-789-00	RES, METAL PLATE			0.1
R728	1-260-072-11	CARBON	4.7	5%	1/2W
R729	1-260-076-11	CARBON	10	5%	1/2W
R730	1-249-407-11	CARBON	150	5%	1/4W
R731	1-249-431-11	CARBON	15K	5%	1/4W
R732	1-249-437-11	CARBON	47K	5%	1/4W
R734	1-249-425-11	CARBON	4.7K	5%	1/4W
R736	1-249-438-11	CARBON	56K	5%	1/4W
R737	1-249-428-11	CARBON	8.2K	5%	1/4W
R739	1-249-429-11	CARBON	10K	5%	1/4W
R740	1-249-427-11	CARBON	6.8K	5%	1/4W
R741	1-249-441-11	CARBON	100K	5%	1/4W
R742	1-249-425-11	CARBON	4.7K	5%	1/4W
R743	1-249-437-11	CARBON	47K	5%	1/4W
R744	1-249-423-11	CARBON	3.3K	5%	1/4W
R751	1-249-417-11	CARBON	1K	5%	1/4W
R752	1-249-435-11	CARBON	33K	5%	1/4W
R753	1-249-411-11	CARBON	330	5%	1/4W
R754	1-249-421-11	CARBON	2.2K	5%	1/4W
R755	1-249-434-11	CARBON	27K	5%	1/4W
R756	1-249-426-11	CARBON	5.6K	5%	1/4W
R757	1-249-425-11	CARBON	4.7K	5%	1/4W
R758	1-249-435-11	CARBON	33K	5%	1/4W
R759	1-249-411-11	CARBON	330	5%	1/4W
△R760	1-249-409-11	CARBON	220	5%	1/4W
△R761	1-249-409-11	CARBON	220	5%	1/4W
R762	1-249-435-11	CARBON	33K	5%	1/4W
△R763	1-249-397-11	CARBON	22	5%	1/4W
R764	1-247-830-11	CARBON	910	5%	1/4W
R765	1-249-412-11	CARBON	390	5%	1/4W
△R766	1-249-397-11	CARBON	22	5%	1/4W
△R767	1-249-393-11	CARBON	10	5%	1/4W
△R768	1-249-393-11	CARBON	10	5%	1/4W
△R769	1-249-423-11	CARBON	3.3K	5%	1/4W
△R770	1-249-417-11	CARBON	1K	5%	1/4W
△R771	1-249-417-11	CARBON	1K	5%	1/4W
△R772	1-249-421-11	CARBON	2.2K	5%	1/4W
△R773	1-247-706-11	CARBON	330	5%	1/4W
△R774	1-247-688-11	CARBON	10	5%	1/4W
△R775	1-247-688-11	CARBON	10	5%	1/4W
△R776	1-214-789-00	RES, METAL PLATE			0.1
△R777	1-214-789-00	RES, METAL PLATE			0.1
R778	1-260-072-11	CARBON	4.7	5%	1/2W
R779	1-260-076-11	CARBON	10	5%	1/2W
R780	1-249-407-11	CARBON	150	5%	1/4W
R781	1-249-431-11	CARBON	15K	5%	1/4W

Remarks

Ref. No.	Part No.	Description				Remarks
R783	1-249-438-11	CARBON	56K	5%	1/4W	
△R954	1-215-917-11	METAL OXIDE	1K	5%	3W	F
△R955	1-215-890-11	METAL OXIDE	470	5%	2W	F
R956	1-249-426-11	CARBON	5.6K	5%	1/4W	
R957	1-249-385-11	CARBON	2.2	5%	1/6W	
R958	1-249-385-11	CARBON	2.2	5%	1/6W	
R959	1-249-385-11	CARBON	2.2	5%	1/6W	
R960	1-249-385-11	CARBON	2.2	5%	1/6W	
R961	1-249-385-11	CARBON	2.2	5%	1/6W	
R962	1-249-385-11	CARBON	2.2	5%	1/6W	
R963	1-249-385-11	CARBON	2.2	5%	1/6W	
R964	1-249-385-11	CARBON	2.2	5%	1/6W	
R965	1-249-385-11	CARBON	2.2	5%	1/6W	
R966	1-249-385-11	CARBON	2.2	5%	1/6W	
R968	1-249-417-11	CARBON	1K	5%	1/4W	
R969	1-249-393-11	CARBON	10	5%	1/4W	
		< RELAY >				
RV701	1-515-356-00	RELAY				
		< VIBRATOR >				
X301	1-577-157-11	VIBRATOR, CERAMIC 8MHz				

*	A-4347-051-A	POWER SUPPLY BOARD, COMPLETE				

		< BASE POST >				
BP901	1-535-139-00	BASE POST 22MM (10MM PITCH) 2P				
BP902	1-535-139-00	BASE POST 22MM (10MM PITCH) 2P				
BP904	1-535-139-00	BASE POST 22MM (10MM PITCH) 2P				
		< CAPACITOR >				
C901	1-161-744-00	CERAMIC	0.01uF		400V	
C911	1-124-557-11	ELECT	1000uF	20%	25V	
C913	1-124-477-11	ELECT	47uF	20%	25V	
C914	1-124-477-11	ELECT	47uF	20%	25V	
C916	1-164-097-11	CERAMIC	0.022uF		50V	
C917	1-164-097-11	CERAMIC	0.022uF		50V	
C918	1-124-903-11	ELECT	1uF	20%	50V	
C919	1-164-097-11	CERAMIC	0.022uF		50V	
C920	1-124-464-11	ELECT	0.22uF	20%	50V	
C921	1-164-097-11	CERAMIC	0.022uF		50V	
C922	1-162-282-31	CERAMIC	100PF	10%	50V	
		< CONNECTOR >				
* CJ901	1-568-826-11	SOCKET, CONNECTOR 7P				
CP902	1-566-690-11	PLUG, CONNECTOR (2.5MM) 2P				

Note:
The components identified by mark △ or dotted line with mark △ are critical for safety. Replace only with part number specified.

Note:
Les composants identifiés par une marque △ sont critiques pour la sécurité. Ne les remplacer que par une pièce portant le numéro spécifié.

POWER SUPPLY **POWER SW** **REAR**

Ref. No.	Part No.	Description	Remarks
< DIODE >			
D911	8-719-200-82	DIODE 11ES2	
D912	8-719-200-82	DIODE 11ES2	
D913	8-719-200-82	DIODE 11ES2	
D914	8-719-200-82	DIODE 11ES2	
D915	8-719-987-63	DIODE 1N4148M	
D916	8-719-987-63	DIODE 1N4148M	
D917	8-719-933-41	DIODE HZS6C3L	
D918	8-719-933-41	DIODE HZS6C3L	
D919	8-719-985-53	DIODE HZS4ALL	
D920	8-719-987-63	DIODE 1N4148M	
< TRANSISTOR >			
Q911	8-729-209-15	TRANSISTOR 2SD2012	
Q922	8-729-119-78	TRANSISTOR 2SC2785-HFE	
Q923	8-729-119-78	TRANSISTOR 2SC2785-HFE	
Q924	8-729-119-76	TRANSISTOR 2SA1175-HFE	
Q925	8-729-119-76	TRANSISTOR 2SA1175-HFE	
Q926	8-729-119-78	TRANSISTOR 2SC2785-HFE	
< RESISTOR >			
R911	1-249-417-11	CARBON 1K 5% 1/4W	
R912	1-249-437-11	CARBON 47K 5% 1/4W	
R913	1-249-433-11	CARBON 22K 5% 1/4W	
R914	1-249-429-11	CARBON 10K 5% 1/4W	
R915	1-249-425-11	CARBON 4.7K 5% 1/4W	
R916	1-249-429-11	CARBON 10K 5% 1/4W	
R917	1-249-417-11	CARBON 1K 5% 1/4W	
R918	1-249-429-11	CARBON 10K 5% 1/4W	
R919	1-249-426-11	CARBON 5.6K 5% 1/4W	
R920	1-249-417-11	CARBON 1K 5% 1/4W	
R921	1-249-426-11	CARBON 5.6K 5% 1/4W	
R922	1-249-396-11	CARBON 18 5% 1/6W	
< RELAY >			
RY901	1-515-701-11	RELAY	
< TRANSFORMER >			
△T902	1-449-993-21	TRANSFORMER, POWER	
< FUSE >			
△F901	1-532-748-11	FUSE, GLASS TUBE 6.3A 125V(Canadian)	
△F901	1-532-749-11	FUSE, GLASS TUBE 8A (US)	

Ref. No.	Part No.	Description	Remarks
*	1-642-685-11	POWER SW BOARD	

< CONNECTOTR >			
* CP101	1-565-295-11	PLUG, CONNECTOR 4P	
< SWITCH >			
S101	1-554-303-21	SWITCH, TACTILE (SYSTEM POWER)	

*	1-642-682-11	REAR BOARD	

< CAPACITOR >			
C801	1-124-927-11	ELECT 4.7uF 20% 100V	
C802	1-162-282-31	CERAMIC 100PF 10% 50V	
C803	1-162-282-31	CERAMIC 100PF 10% 50V	
C804	1-124-477-11	ELECT 47uF 20% 25V	
C805	1-162-191-31	CERAMIC 2.2PF 10% 50V	
C806	1-124-907-11	ELECT 10uF 20% 50V	
C807	1-124-907-11	ELECT 10uF 20% 50V	
C809	1-164-097-11	CERAMIC 0.022uF 50V	
C810	1-136-171-00	FILM 0.33uF 5% 50V	
< CONNECTOTR >			
CJ802	1-569-596-11	PLUG, CONNECTOR (2.5MM) 3P	
* CJ803	1-568-826-11	SOCKET, CONNECTOR 7P	
< DIODE >			
D801	8-719-987-63	DIODE 1N4148M	
D802	8-719-987-63	DIODE 1N4148M	
D803	8-719-987-63	DIODE 1N4148M	
< IC >			
IC801	8-759-502-33	IC S118752	
< COIL >			
L801	1-420-872-00	COIL, AIR CORE	
< TRANSISTOR >			
Q801	8-729-178-42	TRANSISTOR 2SC2784-F	
< RESISTOR >			
R801	1-249-417-11	CARBON 1K 5% 1/4W	
R802	1-249-439-11	CARBON 68K 5% 1/4W	
R803	1-249-419-11	CARBON 1.5K 5% 1/4W	
R804	1-249-439-11	CARBON 68K 5% 1/4W	
R805	1-217-151-00	RES, METAL PLATE 0.22	

<p>Note: The components identified by mark △ or dotted line with mark △ are critical for safety. Replace only with part number specified.</p>	<p>Note: Les composants identifiés par une marque △ sont critiques pour la sécurité. Ne les remplacer que par une pièce portant le numéro spécifié.</p>
--	---

SP SW	SP TM	SURR SP	VOL
-------	-------	---------	-----

Ref. No.	Part No.	Description	Remarks
R806	1-249-389-11	CARBON 4.7 5% 1/4W	
R807	1-249-409-11	CARBON 220 5% 1/4W	
R808	1-249-428-11	CARBON 8.2K 5% 1/4W	
△R809	1-249-393-11	CARBON 10 5% 1/4W	
R810	1-249-435-11	CARBON 33K 5% 1/4W	
		< RELAY >	
RY801	1-515-790-11	RELAY	

*	1-642-690-11	SP SW BOARD	

		< CONNECTOR >	
* CP702	1-564-778-11	PLUG, CONNECTOR (2.5MM) 4P	
		< JACK >	
J701	1-563-347-11	JACK, LARGE TYPE	
		< RESISTOR >	
△R733	1-216-431-11	METAL OXIDE 560 5% 1W F	
△R783	1-216-431-11	METAL OXIDE 560 5% 1W F	
		< SWITCH >	
S701	1-572-812-11	SWITCH, ROTARY SLIDE (SPEAKERS)	

*	1-642-691-11	SP TM BOARD	

		< TERMINAL >	
TM701	1-537-341-11	TERMINAL BOARD (8P SP) (FRONT SPEAKER)	

*	1-642-692-11	SURR SP BOARD	

		< CONNECTOR >	
* CP701	1-506-509-11	PIN, CONNECTOR 4P	
		< TERMINAL >	
TM702	1-537-265-31	TERMINAL BOARD (REAR SPEAKER)	

Ref. No.	Part No.	Description	Remarks
*	1-642-693-11	VOL BOARD	

		< CAPACITOR >	
C421	1-164-097-11	CERAMIC 0.022uF	50V
		< CONNECTOR >	
* CJ421	1-568-828-11	SOCKET, CONNECTOR 9P	
		< VARIABLE RESISTOR >	
RV405	1-241-816-11	RES, VAR, CARBON 100KX4 (MASTER VOLUME)	

		MISCELLANEOUS	

11	1-575-666-11	WIRE, FLAT TYPE (5 CORE)	
14	1-690-114-11	WIRE, FLAT TYPE (7 CORE)	
15	1-590-487-11	WIRE, FLAT TYPE (17 CORE)	
59	1-590-241-11	WIRE, FLAT TYPE (7 CORE)	
8	1-690-588-31	WIRE, FLAT TYPE (9 CORE)	
△CNP901	1-551-478-00	CORD, POWER	
FL101	1-519-663-11	INDICATOR TUBE, FLUORESCENT	
△T901	1-450-806-11	TRANSFORMER, POWER	

		ACCESSORIES & PACKING MATERIALS	

	1-693-023-11	COMMANDER (STANDARD) (RM-U521)	
	3-707-584-31	COVER, BATTERY	
	3-754-877-21	MANUAL, INSTRUCTION (ENGLISH)	
*	4-949-866-02	INDIVIDUAL CARTON	
*	4-949-872-01	CUSHION	

		HARDWARE LIST	

#1	7-682-548-04	SCREW +BVTT 3X8 (S)	
#2	7-682-561-04	SCREW +BVTT 4X8 (S)	
#3	7-682-950-01	SCREW +PSW 3X12	
#4	7-682-949-01	SCREW +PSW 3X10	
#5	7-682-548-09	SCREW +B 3X8	
#6	7-685-646-79	SCREW +BVTP 3X8 TYPE2 N-S	

<p>Note: The components identified by mark △ or dotted line with mark △ are critical for safety. Replace only with part number specified.</p>	<p>Note: Les composants identifiés par une marque △ sont critiques pour la sécurité. Ne les remplacer que par une pièce portant le numéro spécifié.</p>
--	--

TA-AV421

SONY® SERVICE MANUAL

*US Model
Canadian Model*

CORRECTION-1

Correct your service manual as shown below.

The information about the following parts is wrong.
Replace page 28 with this sheet.

- DISPLAY BOARD PART SECTION
- FUSE BOARD PART SECTION
- IC BOARD PART SECTION
- MAIN BOARD PART SECTION

— Continued on next page —

(Replace page 28 with this sheet)

DISPLAY **FUSE** **IC** **MAIN**

Ref. No.	Part No.	Description	Remarks
R448	1-249-417-11	CARBON 1K 5%	1/4W
R449	1-249-421-11	CARBON 2.2K 5%	1/4W
R450	1-249-437-11	CARBON 47K 5%	1/4W
R460	1-249-417-11	CARBON 1K 5%	1/4W
R461	1-247-887-00	CARBON 220K 5%	1/4W
R462	1-249-429-11	CARBON 10K 5%	1/4W
R463	1-249-421-11	CARBON 2.2K 5%	1/4W
R464	1-247-887-00	CARBON 220K 5%	1/4W
R465	1-249-427-11	CARBON 6.8K 5%	1/4W
R466	1-249-438-11	CARBON 56K 5%	1/4W
R472	1-249-441-11	CARBON 100K 5%	1/4W
R474	1-249-414-11	CARBON 560 5%	1/4W
R475	1-249-437-11	CARBON 47K 5%	1/4W
R476	1-249-426-11	CARBON 5.6K 5%	1/4W
R477	1-249-411-11	CARBON 330 5%	1/4W
R901	1-202-725-00	SOLID 3.3M 10%	1/2W
< VARIABLE RESISTOR >			
RV401	1-241-817-11	RES, VAR, CARBON 100K/100K	(BASS)
RV402	1-241-817-11	RES, VAR, CARBON 100K/100K	(TREBLE)
RV403	1-241-427-11	RES, VAR, CARBON 100K	(INPUT BALANCE)
RV404	1-238-965-21	RES, VAR, CARBON 100K/100K	(BALANCE)
< SWITCH >			
S102	1-554-303-21	SWITCH, TACTILE	(PHONO)
S103	1-554-303-21	SWITCH, TACTILE	(TUNER)
S104	1-554-303-21	SWITCH, TACTILE	(CD)
S105	1-554-303-21	SWITCH, TACTILE	(TAPE)
S106	1-554-303-21	SWITCH, TACTILE	(VIDEO)
S107	1-554-303-21	SWITCH, TACTILE	(+)
S108	1-554-303-21	SWITCH, TACTILE	(-)
S111	1-554-303-21	SWITCH, TACTILE	(SURROUND)
S112	1-554-303-21	SWITCH, TACTILE	(HALL)
S113	1-554-303-21	SWITCH, TACTILE	(SIMULATED)
S115	1-554-303-21	SWITCH, TACTILE	(DBFB)
S120	1-554-303-21	SWITCH, TACTILE	(DOLBY)
< VIBRATOR >			
X101	1-577-101-11	VIBRATOR, CERAMIC	4.19MHz

*	1-642-689-11	FUSE BOARD	*****
< FUSE >			
△F951	1-576-109-11	FUSE 5A 125V	
△F952	1-576-109-11	FUSE 5A 152V	

Ref. No.	Part No.	Description	Remarks
*	1-642-696-11	IC BOARD	*****
< CONNECTOR >			
* CP951	1-564-778-11	PLUG, CONNECTOR (2.5MM)	4P
< IC >			
IC953	8-759-604-32	IC M5F7810	
IC956	8-759-604-39	IC AN6291	

*	A-4347-042-A	MAIN BOARD, COMPLETE (US)	*****
*	A-4347-052-A	MAIN BOARD, COMPLETE (Canadian)	*****
< CAPACITOR >			
C301	1-124-907-11	ELECT	10uF 20% 50V
C302	1-162-215-31	CERAMIC	47PF 5% 50V
C303	1-124-907-11	ELECT	10uF 20% 50V
C311	1-124-907-11	ELECT	10uF 20% 50V
C312	1-162-215-31	CERAMIC	47PF 5% 50V
C313	1-124-907-11	ELECT	10uF 20% 50V
C321	1-126-925-11	ELECT	470uF 20% 10V
C322	1-124-927-11	ELECT	4.7uF 20% 100V
C323	1-162-294-31	CERAMIC	0.001uF 10% 50V
C324	1-130-487-00	MYLAR	0.022uF 5% 50V
C325	1-162-284-31	CERAMIC	150PF 10% 50V
C326	1-126-923-11	ELECT	220uF 20% 10V
C327	1-126-923-11	ELECT	220uF 20% 10V
C328	1-164-159-11	CERAMIC	0.1uF 50V
C329	1-126-933-11	ELECT	100uF 20% 16V
C332	1-136-169-00	FILM	0.22uF 5% 50V
C333	1-130-493-00	MYLAR	0.068uF 5% 50V
C334	1-102-124-00	CERAMIC	0.0039uF 10% 50V
C335	1-102-125-00	CERAMIC	4700PF 10% 50V
C336	1-130-489-00	MYLAR	0.033uF 5% 50V
C337	1-124-927-11	ELECT	4.7uF 20% 100V
C338	1-124-903-11	ELECT	1uF 20% 50V
C339	1-124-903-11	ELECT	1uF 20% 50V
C340	1-130-489-00	MYLAR	0.033uF 5% 50V
C341	1-102-126-00	CERAMIC	0.0056uF 10% 50V

<p>Note: The components identified by mark Δ or dotted line with mark Δ are critical for safety. Replace only with part number specified.</p>	<p>Note: Les composants identifiés par une marque Δ sont critiques pour la sécurité. Ne les remplacer que par une pièce portant le numéro spécifié.</p>
--	--

TA-AV421

SONY SERVICE MANUAL

US Model
Canadian Model

CORRECTION-2

Correct your service manual as shown below.

 : Indicates corrected portion.

Page	INCORRECTION	CORRECTION												
30	<table border="1"> <thead> <tr> <th>Ref. No.</th> <th>Part No.</th> <th>Description</th> </tr> </thead> <tbody> <tr> <td>IC951</td> <td>8-759-604-39</td> <td>AN6291</td> </tr> </tbody> </table>	Ref. No.	Part No.	Description	IC951	8-759-604-39	AN6291	<table border="1"> <thead> <tr> <th>Ref. No.</th> <th>Part No.</th> <th>Description</th> </tr> </thead> <tbody> <tr> <td>IC951</td> <td>8-759-604-39</td> <td>M5F78M12L</td> </tr> </tbody> </table>	Ref. No.	Part No.	Description	IC951	8-759-604-39	M5F78M12L
Ref. No.	Part No.	Description												
IC951	8-759-604-39	AN6291												
Ref. No.	Part No.	Description												
IC951	8-759-604-39	M5F78M12L												

Page 18-19 (2-5. SCHEMATIC DIAGRAM — MAIN SECTION —)

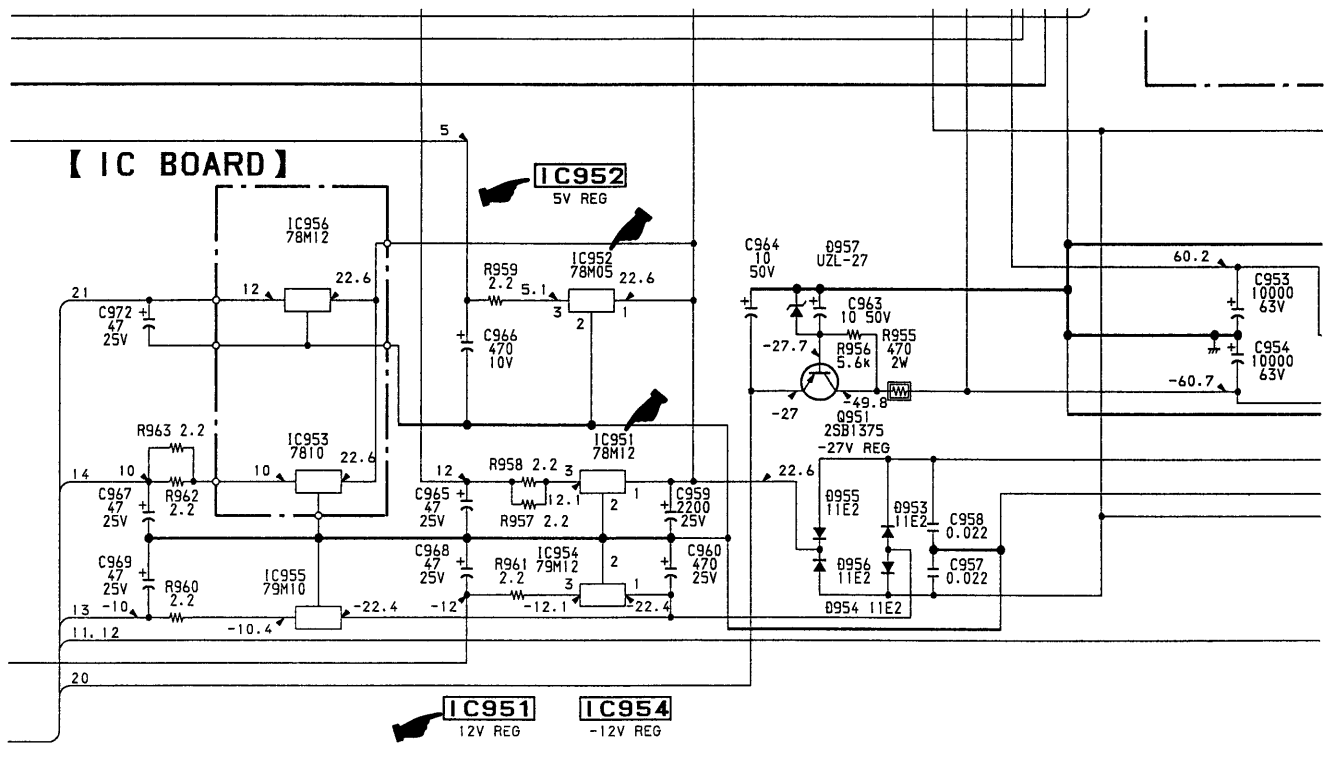

TA-AV421

SONY SERVICE MANUAL

US Model
Canadian Model

CORRECTION-3

Correct your service manual as shown below.

- TA-AV421 is the amplifier section of the stereo component system SEN-421CD.

 : indicates corrected portion.

Page	INCORRECT			CORRECT	
	No.	Part No.	Description	Part No.	Description
34	ACCESSORIES & PACKING MATERIALS			ACCESSORIES & PACKING MATERIALS	
		1-693-023-11	COMMANDER (STANDARD) (RM-U521)	* 4-949-872-01	CUSHION
		3-707-584-31	COVER, BATTERY		
		3-754-877-21	MANUAL, INSTRUCTION (ENGLISH)		
	*	4-949-866-02	INDIVIDUAL CARTON		
*	4-949-872-01	CUSHION			

(RPC-95041)